

KEEP
STRESS
AWAY

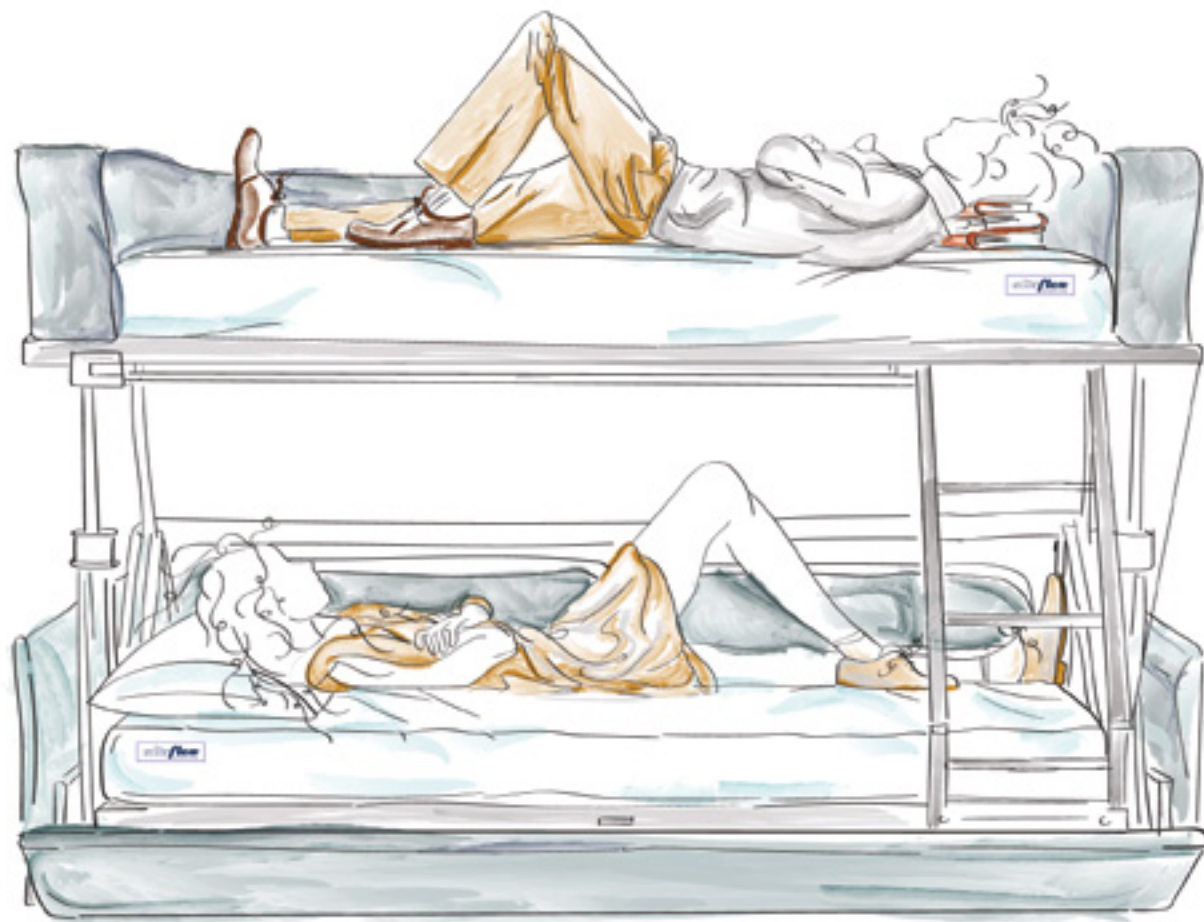

altaflex[®]
made in italy Sofa bed mechanisms



Indice

Meccanismi a ribalta - SERIE M20

Genius.....	8
Genius Doga.....	10
Materassi per Genius.....	12

Meccanismi a ribalta - SERIE M18

Height Comfort Privilege.....	18
Height Comfort Privilege Doga.....	20
Height Comfort Fast.....	22
Height Comfort Fast Doga.....	24
Materassi per Height Comfort.....	26

Meccanismi a ribalta - SERIE M14

Mec Plus+ M14.....	30
New Roller.....	32
New Roller Doga.....	34
Fast.....	36
Fast Doga.....	38
Smart Piede 13.....	40
Smart Piede 13 Doga.....	42
Materassi.....	44
Mec Plus+ M14 - Roller - Fast - Smart Piede 13	

Meccanismi a ribalta - SERIE EXTRA

Extra Smart Piede 8.....	50
Extra Smart Piede 8 Doga.....	52
Extra Smart Piede 13.....	54
Extra Smart Piede 13 Doga.....	56
Materassi per Extra Smart.....	58

Accessori

Penisola per New Roller / Fast.....	60
Accessori per meccanismi a ribalta.....	62
Lift up Piede 8.....	64
Lift up Piede13.....	65

Meccanismi da inserimento

Slalom.....	68
Large.....	69
Duepieghe.....	70
Duepieghe Italia.....	71
Duepieghe mini.....	72
Tre pieghe.....	74
Materassi.....	76
Slalom - Large- Due pieghe - Due Pieghe mini - Tre pieghe	

Meccanismi trasformabili

Roma.....	80
Duplex superiore doghe.....	84
Duplex inferiore doghe.....	85
Duplex inferiore lampo doghe.....	85
Duplex superiore elettrosaldato.....	86
Duplex inferiore elettrosaldato.....	87
Duplex inferiore lampo elettrosaldato.....	87
Space.....	88
Space double.....	90
Ciak.....	91
Materassi.....	92
Duplex, space	
Accessori.....	93
Evening.....	94
Accessori e materassi.....	95
Evening	
Pouff.....	96
Pouff con centina.....	97

Meccanismi per letto

Raffaello.....	100
System.....	102
Asiago.....	104
Picasso.....	106

**Dalle mani esperte di maestri fabbri
nascono forme e stili
che hanno fatto dell'Altaflex srl
un'azienda leader nel settore**



La dedizione, la cura dei particolari, i materiali e la tecnologia hanno fatto sì che del prodotto non solo si mantenesse alto lo standard qualitativo ma che lo stesso fosse altamente competitivo.

La vasta gamma di meccanismi per divani, con telai metallici accuratamente verniciati con polveri epossidiche, rispettano rigorosamente proprietà di eleganza, comodità e resistenza nel tempo: meccanismi dal design eccellente, maneggevoli ed accuratamente studiati per garantire il giusto utilizzo.

Nelle più svariate forme e dimensioni i nostri meccanismi sono da anni richiesti dai più prestigiosi costruttori di divani letto; segno evidente della bontà dei nostri esemplari.

Il mix di fattori di successo è valorizzato dalla realizzazione di materassi unici e progettati appositamente per i nostri meccanismi, i quali soddisfano le esigenze di tutti i clienti con il loro tocco di eleganza e stile.

L'elevato livello della performance aziendale è raggiunto sia grazie ad uno staff di collaboratori esperti e altamente professionali, sia grazie alla tenacia e al coraggio che hanno motivato il gruppo Cannito leader dell'ALTAFFLEX SRL.

Intuendo le tendenze, anticipandole e consolidandole nel tempo, Altaflex ha maturato una energica esperienza nella produzione di meccanismi per salotti e materassi di ogni tipologia.



Ci prendiamo cura del tuo relax We take care of your relax



Dedication, attention to detail, materials and technology mean that not only has the standard of product quality been kept at the highest level, but that the very same products are extremely competitive. A vast range of mechanisms for sofas, with metal frames carefully painted using epoxy powders, perfectly respects the characteristics of elegance, comfort and durability: These mechanisms, with their excellent design, are easy to handle and carefully devised to offer perfect use. They are available in a host of different shapes and sizes and for years now they have been a firm favourite with the most important manufacturers of sofa beds - an evident sign of the excellence of our products. For each mesh base, ALTALEX Srl manufactures a specific mattress to complete its functional use. The mix of factors behind this success is greatly increased by the presence at ALTALEX Srl of a committed, professional staff that follows the product from the choice of raw materials through to its arrival on the market, ensuring full compliance with a host of different customer requirements. Company performance of the highest level has been achieved thanks to the tenacity and courage that motivate the Cannito Group at the head of ALTALEX Srl, which, sensing trends, anticipating them and consolidating them over time, has gained active experience in manufacturing mechanisms for lounge suites.

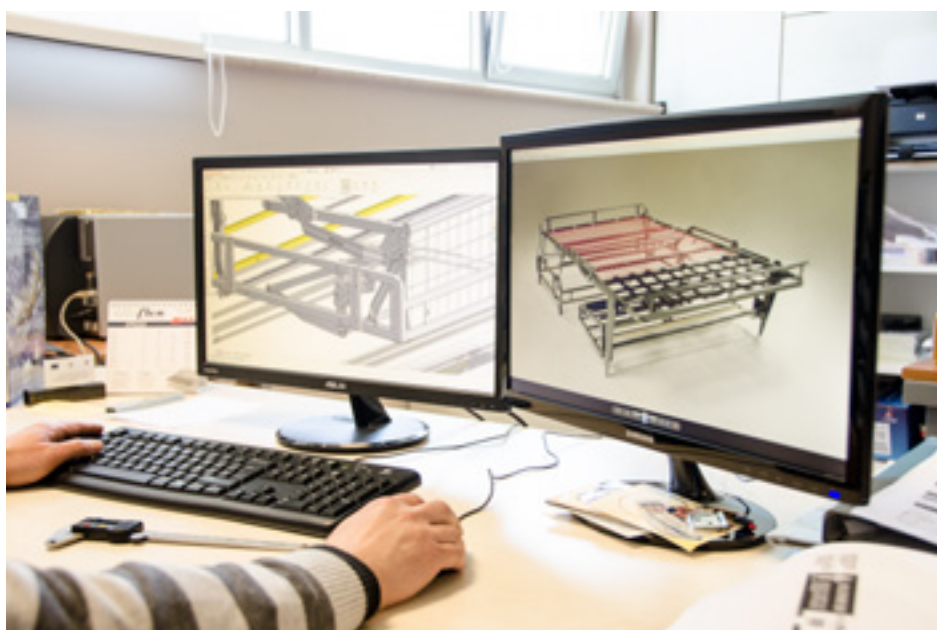

**From the expert hands of master craftsmen
come the forms and styles
that have made ALTALEX Srl
a leading company in its field**

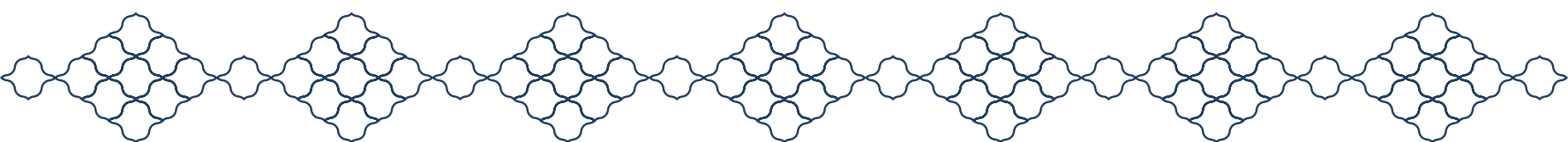

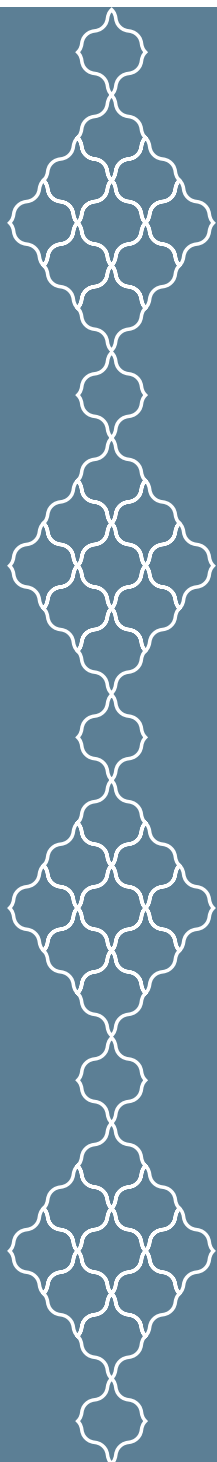
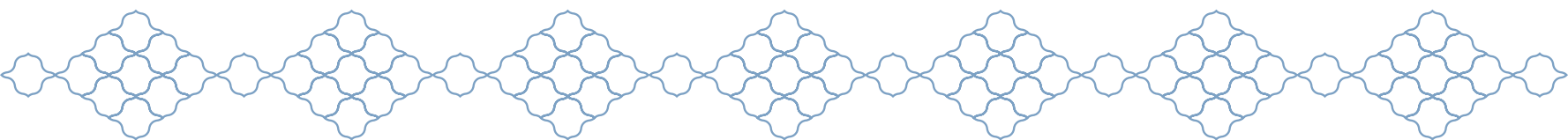

SERIE
M20



**MECCANISMI
A RIBALTA**

REVOLVING
MECHANISMS

altaflex
sofa bed mechanisms



WWW.ALTALEX.IT





Genius

Meccanismo a ribalta progettato per l'inserimento di un materasso H20

Meccanismo a ribalta progettato per l'inserimento di un materasso H20.

Geniale sistema a ribalta che, con un semplice movimento, consente l'apertura del meccanismo senza rimuovere i cuscini dalla seduta e dallo schienale. Il meccanismo Genius permette di inserire un vero materasso da letto da H20 cm, mantenendo le caratteristiche di un confortevole divano.

La Genius è fortemente consigliata per chi utilizza giornalmente il divano-letto con il comfort di un comodo materasso da letto.

Il piano dormita, con rete in acciaio elettrosaldato e cinghie elastiche, rendono confortevole il momento del riposo.

Revolving mechanism Genius

is specially designed for H20 cm mattresses.

This clever revolving mechanism with a simple and unique opening system converts into a bed. Seat and back cushions are fixed to the frame during the opening action.

Genius mechanism with its H20 cm mattress is highly recommended for a daily domestic use.

The sleeping surface is made of electrowelded steel mesh and elastic belts ensuring a high comfort for your rest.



- Meccanismo accessoriato con portaganciale doppio
Mechanism equipped with a double pillow storage



ARTICOLO	A	B	DIMENSIONI consigliate del MATERASSO
Mec 122 GENIUS 182	182	165	160x195x20
Mec 122 GENIUS 162	162	145	140x195x20
Mec 122 GENIUS 142	142	125	120x195x20
Mec 122 GENIUS 122	122	105	100x195x20
Mec 122 GENIUS 92	92	75	70x195x20

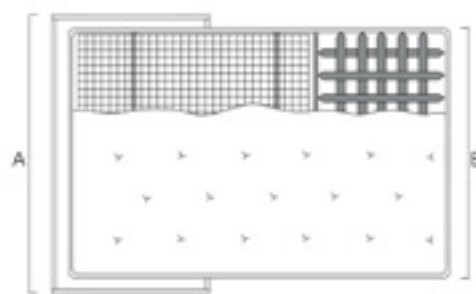
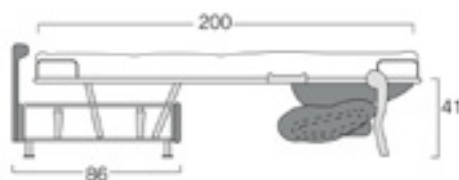



- Materasso altezza 20 cm
H 20 cm mattress



Meccanismo indicato per un uso quotidiano
Advised for daily use



Genius Doga

Meccanismo a ribalta con piano dormita a doghe con regolatori di rigidità

Geniale sistema a ribalta, che con un semplice movimento consente l'apertura del meccanismo senza rimuovere i cuscini dalla seduta e dallo schienale. Il meccanismo Genius Doga permette di inserire un materasso H 18 cm, sempre più simile a un materasso da letto; mantenendo le caratteristiche di un confortevole divano.

La Genius Doga è fortemente consigliata per chi utilizza giornalmente il divano in modalità letto e necessita di un piano dormita adattabile alle proprie esigenze, grazie alle 4 regolazioni effettuabili su ciascun posto in modo indipendente e semplice.

Il piano dormita utilizza doghe in legno (materiale green - ecocompatibile) di varie rigidità che determinano un piano dormita differenziato a zone e regolabile in modo semplice da qualsiasi utilizzatore.

This clever revolving mechanism with a simple and unique opening system converts into a bed. Seat and back cushions are fixed to the frame during the opening action. Mec Genius with wooden slats is available to accommodate a mattress H18 cm, that grants the well-being of a real bed mattress.

Genius mechanism wooden slats is made of two independent sleeping surfaces. It is dedicated to people who need a customized tension adjustment with its 4 levels.

The sleeping surface is made of wooden slats (green - eco friendly) that have various tension levels for a differentiated and adjustable sleeping surface.

ARTICOLO	A	B	DIMENSIONI consigliate del MATERASSO
Mec 122 GENIUS 182	182	165	160x195x18
Mec 122 GENIUS 162	162	145	140x195x18
Mec 122 GENIUS 142	142	125	120x195x18
Mec 122 GENIUS 122	122	105	100x195x18
Mec 122 GENIUS 92	92	75	70x195x18



- Meccanismo accessoriato con portaguanciaie doppio
Mechanism equipped with a double pillow storage

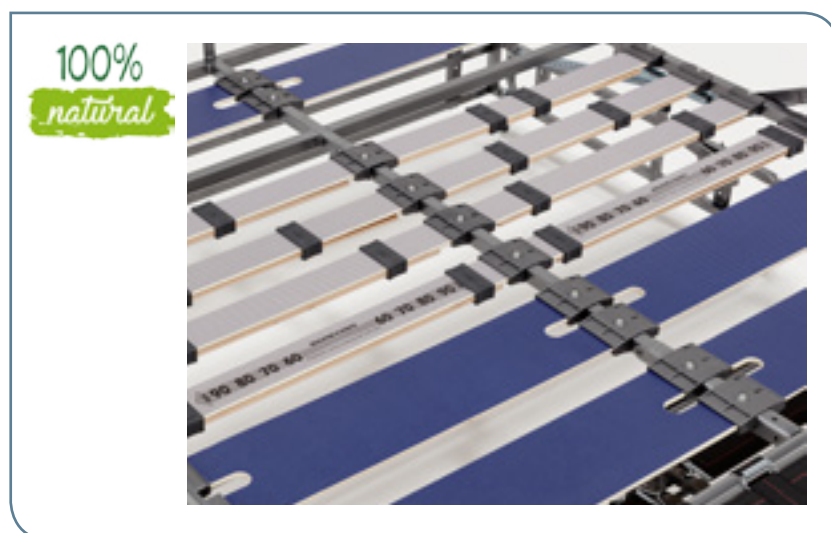

- Piano dormita a doghe con rigidità regolabile
Wooden slats surface with tension adjuster

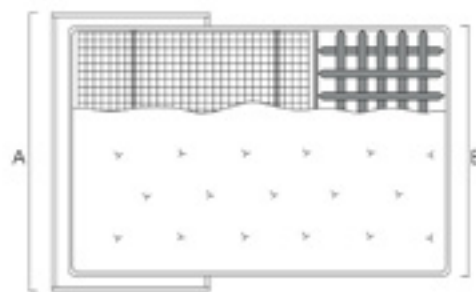
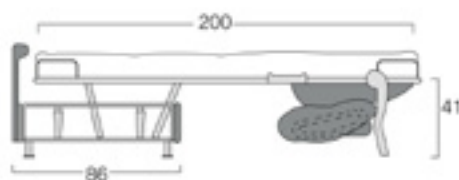



- Materasso altezza 18 cm
H 18 cm mattress



Meccanismo indicato per un uso quotidiano
Advised for daily use

1



2



3



Materassi per Genius



Anallergico
Antibacterial - anti mite



Tessuto stretch
Stretch fabric



Fascia traspirante 3D
3D breathable band

Materasso H20 Genius D25 Stretch

Con i suoi 20 cm H, il Materasso Genius D25 si colloca nella fascia di materassi da letto assicurandone massimo comfort nel tempo. È consigliato per un uso quotidiano del divano trasformabile e vuole avere il massimo comfort di un vero materasso da letto H 20 cm. Rivestito con tessuto stretch anallergico e fascia traspirante.

Genius Mattress D25 Stretch cover with its H20 cm is considered a real bed mattress ensuring high comfort over time. It is highly recommended for a daily use of the sofa bed. Covered with an hypoallergenic stretch fabric and 3D breathable band.

misure meccanismo (cm)	dimensione materasso (cm)	GENIUS ELETTRCINGHIA	GENIUS DOGA
182	160x195x20	✓	✗
162	140x195x20	✓	✗
142	120x195x20	✓	✗
122	100x195x20	✓	✗
92	70x195x20	✓	✗

Materasso H20 Genius D30 Memory Stretch

Con i suoi 20 cm H, il materasso Genius Memory D30 si colloca nella fascia di materassi da letto con massimo comfort ed è ideale per coloro che desiderano riposare su una superficie non troppo rigida e non troppo morbida. È consigliato per un uso quotidiano del divano trasformabile e vuole avere il massimo comfort di un vero materasso da letto H 20 cm. Rivestito con tessuto stretch anallergico e design da materasso letto.

Genius Mattress D30 Memory Stretch cover with its H20 cm is considered a real bed mattress and is recommended to people who want to rest on a sleeping surface that is not too rigid and not too soft. It is perfect for a domestic daily use of the sofa bed guaranteeing the well-being of a real bed mattress.



Anallergico
Antibacterial - anti mite



Memory foam
Confort memory



Tessuto stretch
Stretch fabric



Alta densità
High density



Fascia traspirante 3D
3D breathable band



misure meccanismo (cm)	dimensione materasso (cm)	GENIUS ELETTRCINGHIA	GENIUS DOGA
182	160x195x20	✓	✗
162	140x195x20	✓	✗
142	120x195x20	✓	✗
122	100x195x20	✓	✗
92	70x195x20	✓	✗



I Materassi sono disponibili anche nelle versioni ignifughe CLASSE 1 IM - BS 7177 - 16 CFR 1632 e 16 CFR 1633



Anallergico
Antibacterial - anti mite



Memory foam
Confort memory



Tessuto stretch
Stretch fabric



Alta densità
High density



Fascia traspirante 3D
3D breathable band

Materasso H20 Genius D30 Memory Topper Fisso

Con i suoi 20 cm H il Materasso GENIUS MEMORY D.30 si colloca nella fascia di materassi da letto e grazie alla sua struttura combinata in Memory Foam e Poliuretano, garantisce una maggiore ergonomia donando un confort incomparabile ed apprezzabile nel tempo. È consigliato per un uso quotidiano del divano trasformabile e vuole avere il massimo confort di un vero materasso da letto H 20 cm. Rivestito con tessuto stretch anallergico e design moderno.

Genius Mattress D30 Memory Stretch cover with its H20 cm is considered a real bed mattress. The combination of Memory Foam and Polyurethane ensures the maximum expression of ergonomic and comfort. It is perfect for a domestic daily use of the sofa bed guaranteeing the well-being of a real bed mattress. Covered with a stylish and hypoallergenic stretch fabric.

misure meccanismo (cm)	dimensione materasso (cm)	GENIUS ELETTRCINGHIA	GENIUS DOGA
182	160x195x20	✓	✗
162	140x195x20	✓	✗
142	120x195x20	✓	✗
122	100x195x20	✓	✗
92	70x195x20	✓	✗

Materasso H18 Genius Memory Molle Indipendenti

Il Materasso Genius Molle Indipendenti, abbinato a materiali innovativi quali il Memory Foam, consente la realizzazione di un materasso ad alto profilo ergonomico, che allontana dolori articolari, mal di schiena e spossatezza. È consigliato per un uso quotidiano del divano trasformabile. Rivestito con tessuto stretch anallergico e con struttura costituita da circa 700 molle insacchettate indipendenti, che offre il sostegno delle molle e una piacevole sensazione di avvolgente accoglienza.

Genius mattress D30 INDEPENDENT SPRINGS combined to innovative materials such as Memory Foam guarantees an ergonomic mattress, that prevents from joint pains, backache and tiredness. It is perfect for a domestic daily use of the sofa bed. The mattress is made of 700 independent pocket springs and covered with hypoallergenic and stretch fabric guaranteeing the support of a spring surface and a pleasant contact with the body.



Anallergico
Antibacterial - anti mite



Tessuto stretch
Stretch fabric



Memory foam
Confort memory



Molle insacchettate
Spring pockets



misure meccanismo (cm)	dimensione materasso (cm)	GENIUS ELETTRCINGHIA	GENIUS DOGA
182	160x195x18	✓	✓
162	140x195x18	✓	✓
142	120x195x18	✓	✓
122	100x195x18	✓	✓
92	70x195x18	✓	✓



I Materassi sono disponibili anche nelle versioni ignifughe CLASSE 1 IM - BS 7177 - 16 CFR 1632 e 16 CFR 1633

Materassi per Genius



Anallergico
Antibacterial - anti mite



Tessuto stretch
Stretch fabric



Memory foam
Comfort memory



Alta densità
High density

Materasso H18 Height Comfort D30 Memory

Con i suoi 18 cm H il Materasso Height Comfort Memory D30, si colloca nella fascia di materassi da letto e grazie alla sua struttura combinata in Memory Foam e Poliuretano, garantisce una maggiore ergonomia donando un comfort incomparabile. È consigliato per un uso quotidiano del divano trasformabile. Rivestito con tessuto stretch anallergico e design moderno.

Mattress H18 Height Comfort D30 Memory is considered a real bed mattress. The combination of Memory Foam and Polyurethane ensure the maximum expression of ergonomic and comfort. Covered with a stylish and hypoallergenic stretch fabric.

misure meccanismo (cm)	dimensione materasso (cm)	GENIUS ELETTRCINGHIA	GENIUS DOGA
182	160x195x18	✓	✓
162	140x195x18	✓	✓
142	120x195x18	✓	✓
122	100x195x18	✓	✓
92	70x195x18	✓	✓

Materasso H18 Height Comfort D30 Stretch

Con i suoi 18 cm H, il Materasso Height Comfort D30 ad alta densità, si colloca nella fascia di materassi da letto assicurandone massimo comfort. È consigliato per un uso quotidiano del divano trasformabile. Rivestito con tessuto stretch anallergico e fascia traspirante 3D.

Mattress H18 Height Comfort D30 Stretch with high density is considered a real bed mattress. Covered with an hypoallergenic stretch fabric and 3D breathable band.



Anallergico
Antibacterial - anti mite



Tessuto stretch
Stretch fabric



Alta densità
High density



Fascia traspirante 3D
3D breathable band



misure meccanismo (cm)	dimensione materasso (cm)	GENIUS ELETTRCINGHIA	GENIUS DOGA
182	160x195x18	✓	✓
162	140x195x18	✓	✓
142	120x195x18	✓	✓
122	100x195x18	✓	✓
92	70x195x18	✓	✓



I Materassi sono disponibili anche nelle versioni ignifughe CLASSE 1 IM - BS 7177 - 16 CFR 1632 e 16 CFR 1633



Anallergico
Antibacterial - anti mite



Tessuto stretch
Stretch fabric



Fascia traspirante 3D
3D breathable band

Materasso H17 Height Comfort D25 Stretch

Con i suoi 17 cm H, il Materasso Height Comfort D25 a media densità, si colloca nella fascia di materassi da letto assicurandone massimo comfort. È consigliato per un uso quotidiano del divano trasformabile. Rivestito con tessuto stretch anallergico e fascia traspirante 3D.

Mattress H17 Height Comfort D25 Stretch with medium density is considered a real bed mattress. Covered with an hypoallergenic stretch fabric and 3D breathable band.

misure meccanismo (cm)	dimensione materasso (cm)	GENIUS ELETTRICINGHIA	GENIUS DOGA
182	160x195x17	✓	✓
162	140x195x17	✓	✓
142	120x195x17	✓	✓
122	100x195x17	✓	✓
92	70x195x17	✓	✓



I Materassi sono disponibili anche nelle versioni ignifughe CLASSE 1 IM - BS 7177 - 16 CFR 1632 e 16 CFR 1633

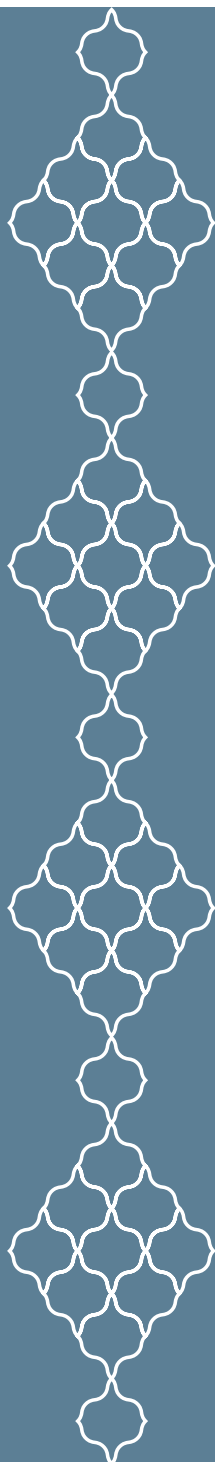
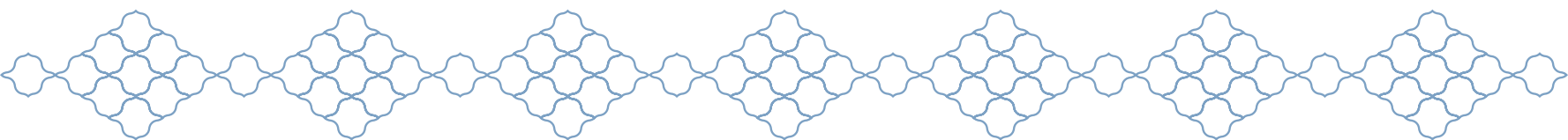

SERIE
M18



**MECCANISMI
A RIBALTA**

REVOLVING
MECHANISMS

altaflex
sofa bed mechanisms



WWW.ALTALEX.IT



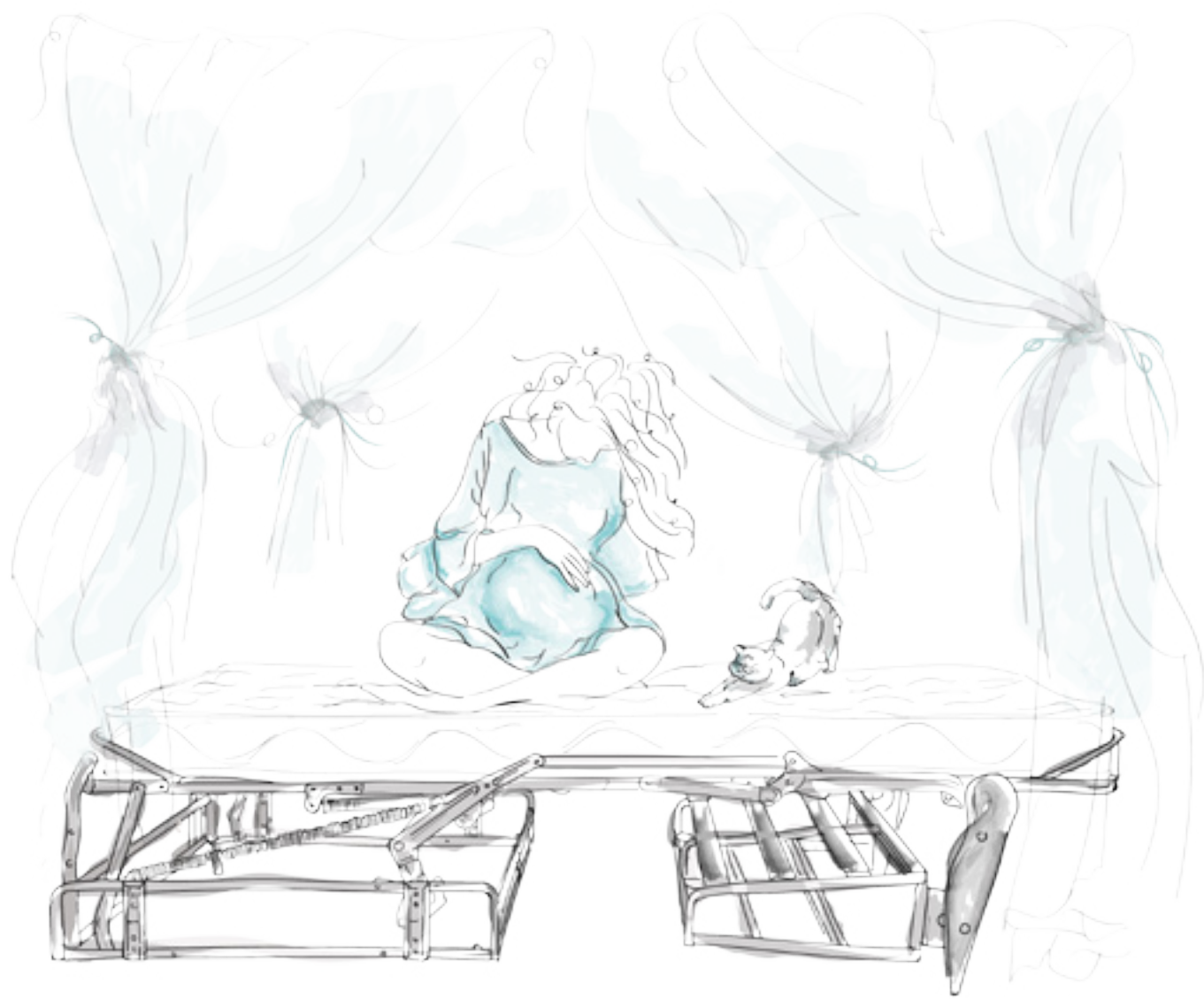

Height Comfort Privilege

Meccanismo a ribalta progettato per l'inserimento di un materasso H18

Innovativo sistema a ribalta, che con un semplice movimento consente l'apertura del meccanismo senza rimuovere i cuscini dalla seduta e dallo schienale. Il meccanismo Height Comfort Privilege permette di inserire un materasso da H 18 cm, sempre più simile ad un materasso da letto. L'Height Comfort Privilege è fortemente consigliato per un uso quotidiano del divano. Il piano dormita è con rete in acciaio elettrosaldato e cinghie elastiche che rendono confortevole il momento del riposo.

Revolving mechanism Height Comfort Privilege with wooden slats and tension adjusters.

This clever revolving mechanism with a simple and unique opening system converts into a bed. Seat and back cushions are fixed to the frame. Height Comfort Privilege with wooden slats is available to accommodate a mattress H16 cm, that grants the well-being of a real bed mattress. Height Comfort Privilege wooden slats is made of two independent sleeping surfaces. It is dedicated to people who need a customized tension adjustment with its 4 levels.

The sleeping surface is made of wooden slats (green - eco friendly) that have various tension levels for a differentiated and adjustable sleeping surface.



- Meccanismo accessoriato con spalliera standard
Mechanisms equipped with standard backrest



ARTICOLO	A	B	DIMENSIONI consigliate del MATERASSO
Mec 106 Height comfort 182	182	165	160x196x18
Mec 106 Height comfort 162	162	145	140x196x18
Mec 106 Height comfort 142	142	125	120x196x18
Mec 106 Height comfort 122	122	105	100x196x18
Mec 106 Height comfort 92	92	75	70x196x18

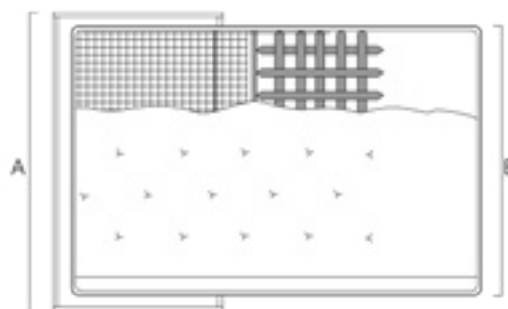
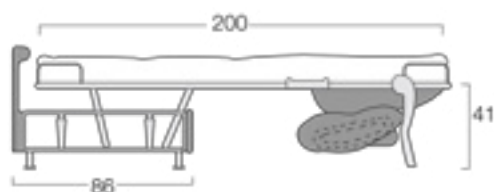



- Materasso altezza 18 cm
H 18 cm mattress



Meccanismo indicato per un uso quotidiano
Advised for daily use

1



2



3



Height Comfort Privilege Doga

Meccanismo a ribalta con piano dormita a doghe con regolatori di rigidità

Innovativo sistema a ribalta, che con un semplice movimento consente l'apertura del meccanismo senza rimuovere i cuscini dalla seduta e dallo schienale. Il meccanismo Height Comfort Privilege Doga permette di inserire un materasso H 16 cm, simile a un materasso da letto pur mantenendo le caratteristiche di un confortevole divano.

L'Height Comfort Privilege Doga è fortemente consigliata per chi utilizza giornalmente il divano in modalità letto e necessita di un piano dormita adattabile alle proprie esigenze, grazie alle 4 regolazioni effettuabili su ciascun posto in modo indipendente e semplice.

Il piano dormita utilizza doghe in legno (materiale green - ecocompatibile) di varie rigidità che determinano un piano dormita differenziato a zone e regolabile in modo semplice da qualsiasi utilizzatore.

Revolving mechanism Height Comfort Privilege with wooden slats and tension adjusters.

This clever revolving mechanism with a simple and unique opening system converts into a bed. Seat and back cushions are fixed to the frame during the opening action. Height Comfort Privilege with wooden slats is suitable to accommodate a mattress H16 cm, that grants the well-being of a real bed mattress.

Height Comfort Privilege wooden slats is made of two independent sleeping surfaces. It is dedicated to people who need a customized tension adjustment with its 4 levels.

The sleeping surface is made of wooden slats (green - eco friendly) that have various tension levels for a differentiated and adjustable sleeping surface.

ARTICOLO	A	B	DIMENSIONI consigliate del MATERASSO
Mec 106 HEIGHT COMFORT 182	182	165	160x195x16
Mec 106 HEIGHT COMFORT 162	162	145	140x195x16
Mec 106 HEIGHT COMFORT 142	142	125	120x195x16
Mec 106 HEIGHT COMFORT 122	122	105	100x195x16
Mec 106 HEIGHT COMFORT 92	92	75	70x195x16

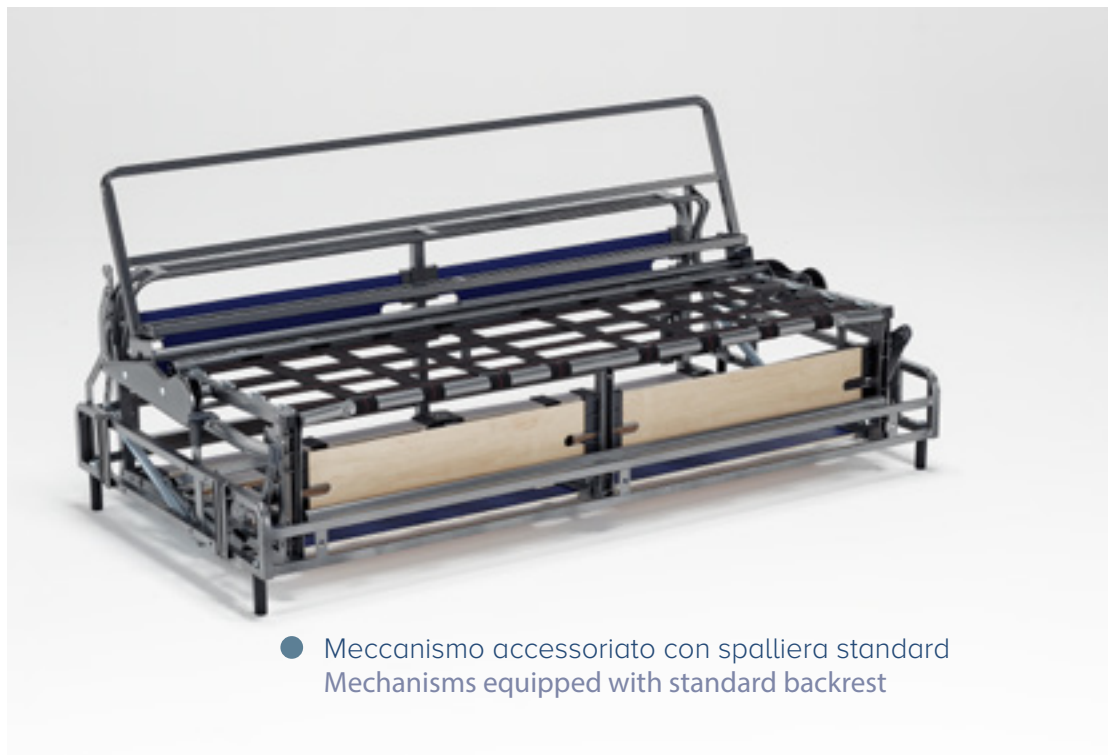

- Meccanismo accessoriato con spalliera standard
Mechanisms equipped with standard backrest

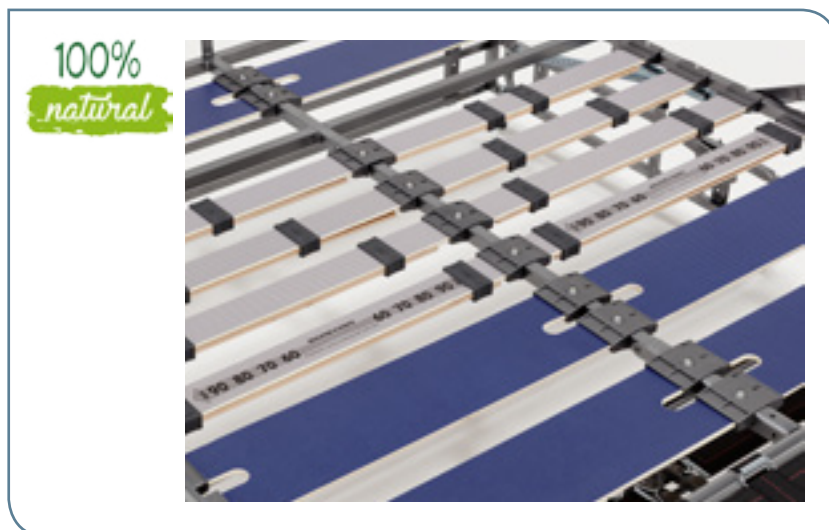

- Piano dormita a doghe con rigidità regolabile
Wooden slats surface with tension adjuster

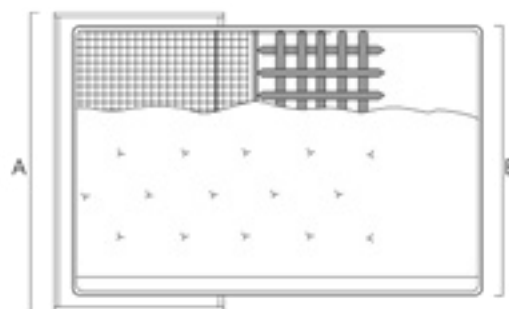
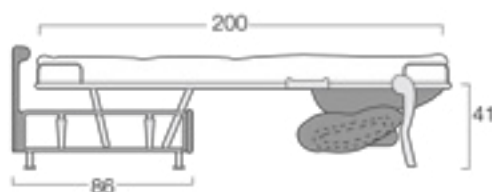



- Materasso altezza 16 cm
H 16 cm mattress



Meccanismo indicato per un uso quotidiano
Advised for daily use

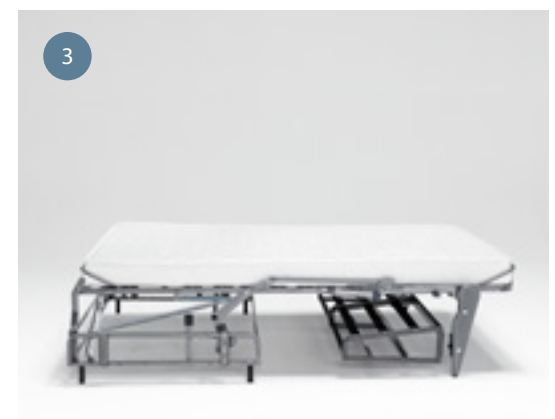

Height Comfort Fast

Meccanismo a ribalta progettato per l'inserimento di un materasso H18

Innovativo sistema a ribalta, che con un semplice movimento consente l'apertura del meccanismo senza rimuovere i cuscini dalla seduta e dallo schienale. Il meccanismo Height Comfort Fast permette di inserire un materasso da H 18 cm, sempre più simile ad un materasso da letto. L'Height Comfort Fast è fortemente consigliato per un uso quotidiano del divano. Il piano dormita è con rete in acciaio elettrosaldata e cinghie elastiche che rendono confortevole il momento del riposo.

Innovative revolving sofa system, that with a simple and single opening process makes it possible to leave the seat and back cushions in place on the sofa. With this mechanism you can use a H 18 cm Mattress, that can be compared more and more to a real mattress bed, recommended and advised for daily use. Sleeping surface with base in fuse-bonded steel and elastic straps for a better sleeping moment.



- Meccanismo accessoriato con portaguanciaie unico
Mechanisms equipped with one pillow holder



ARTICOLO	A	B	DIMENSIONI consigliate del MATERASSO
Mec 106 Height comfort 182	182	165	160x196x18
Mec 106 Height comfort 162	162	145	140x196x18
Mec 106 Height comfort 142	142	125	120x196x18
Mec 106 Height comfort 122	122	105	100x196x18
Mec 106 Height comfort 92	92	75	70x196x18

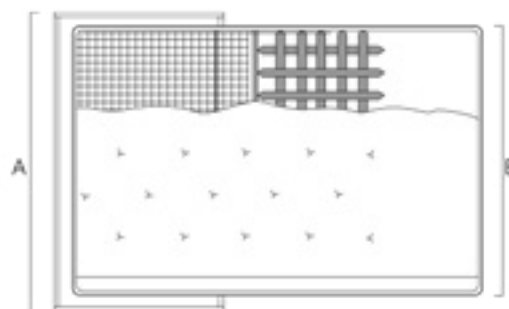
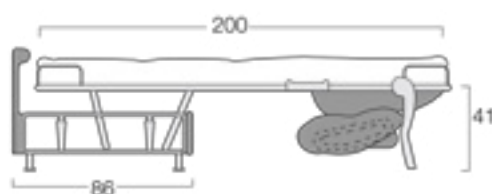



- Materasso altezza 18 cm
H 18 cm mattress



- Disponibile anche con accessorio
Carter ABS copri piede
Also available with ABS Carter
footrest cover



Height Comfort Fast Doga

Meccanismo a ribalta con piano dormita a doghe

Innovativo sistema a ribalta, che con un semplice movimento consente l'apertura del meccanismo senza rimuovere i cuscini dalla seduta e dallo schienale. Il meccanismo Height Comfort Fast Doga permette di inserire un materasso H 16 cm, simile a un materasso da letto; mantenendo le caratteristiche di un confortevole divano.

L'Height Comfort Fast Doga è fortemente consigliata per chi utilizza giornalmente il divano in modalità letto e necessita di un piano dormita altamente confortevole ed ergonomico. Il piano dormita utilizza doghe in legno (materiale green - ecocompatibile) che rendono il piano dormita ortopedico.

Revolving mechanism Height Comfort Fast with wooden slats.

This clever revolving mechanism with a simple and unique opening system converts into a bed. Seat and back cushions are fixed to the frame during the opening action.

Height Comfort Fast with wooden slats is suitable to accommodate a mattress H16 cm, that grants the well-being of a real bed mattress.

Height Comfort Fast with wooden slats is highly recommended for a daily domestic use, because of its ergonomic and comfortable sleeping surface.

The sleeping surface made of wooden slats (green - eco friendly) ensures an orthopedic support.



- Meccanismo accessoriato con portaguanciaie unico
Mechanisms equipped with one pillow holder



ARTICOLO	A	B	DIMENSIONI consigliate del MATERASSO
Mec 106 HEIGHT COMFORT 182	182	165	160x195x16
Mec 106 HEIGHT COMFORT 162	162	145	140x195x16
Mec 106 HEIGHT COMFORT 142	142	125	120x195x16
Mec 106 HEIGHT COMFORT 122	122	105	100x195x16
Mec 106 HEIGHT COMFORT 92	92	75	70x195x16

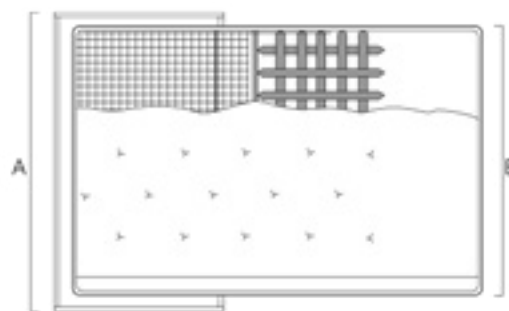
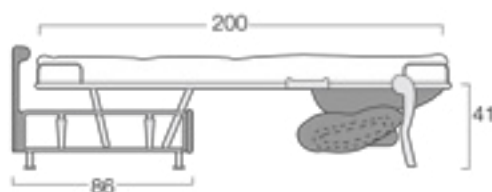



- Materasso altezza 16 cm
H 16 cm mattress



- Disponibile anche con accessorio
Carter ABS copri piede
Also available with ABS Carter
footrest cover



Materassi per Height Comfort



Anallergico
Antibacterial - anti mite



Tessuto stretch
Stretch fabric



Alta densità
High density



Memory foam
Confort memory

Materasso H18 Height Comfort D30 Memory

Con i suoi 18 cm H il Materasso Height Comfort Memory D30 si colloca nella fascia di materassi da letto e grazie alla sua struttura combinata in Memory Foam e Poliuretano, garantisce una maggiore ergonomia donando un comfort incomparabile. Rivestito con tessuto stretch anallergico e design moderno.

Mattress H18 Height Comfort D30 Memory is considered a real bed mattress. The combination of Memory Foam and Polyurethane ensures the maximum expression of ergonomic and comfort. Covered with a stylish and hypoallergenic stretch fabric.

misure meccanismo (cm)	dimensione materasso (cm)	HEIGHT COMFORT PRIVILEGE	HEIGHT COMFORT PRIVILEGE DOGA	HEIGHT COMFORT FAST	HEIGHT COMFORT FAST DOGA
182	160x195x18	✓	✗	✓	✗
162	140x195x18	✓	✗	✓	✗
142	120x195x18	✓	✗	✓	✗
122	100x195x18	✓	✗	✓	✗
92	70x195x18	✓	✗	✓	✗

Materasso H18 Height Comfort D30 Stretch

Con i suoi 18 cm H il Materasso Height Comfort Stretch D30 ad alta densità si colloca nella fascia di materassi da letto assicurandone massimo comfort. Rivestito con tessuto stretch anallergico e fascia traspirante 3D.

Mattress H18 Height Comfort Stretch D30 with high density is considered a real bed mattress. Covered with an hypoallergenic stretch fabric and 3D breathable band.

misure meccanismo (cm)	dimensione materasso (cm)	HEIGHT COMFORT PRIVILEGE	HEIGHT COMFORT PRIVILEGE DOGA	HEIGHT COMFORT FAST	HEIGHT COMFORT FAST DOGA
182	160x195x18	✓	✗	✓	✗
162	140x195x18	✓	✗	✓	✗
142	120x195x18	✓	✗	✓	✗
122	100x195x18	✓	✗	✓	✗
92	70x195x18	✓	✗	✓	✗



Anallergico
Antibacterial - anti mite



Tessuto stretch
Stretch fabric



Alta densità
High density



Fascia traspirante 3D
3D breathable band



Materasso H17 Height Comfort D25 Stretch

Con i suoi 17 cm H il Materasso Height Comfort D25 Stretch a media densità, si colloca nella fascia di materassi da letto assicurandone massimo comfort. Rivestito con tessuto stretch anallergico e fascia traspirante 3D.

Mattress H17 Height Comfort D25 Stretch with medium density is considered a real bed mattress. Covered with an hypoallergenic stretch fabric and 3D breathable band.

misure meccanismo (cm)	dimensione materasso (cm)	HEIGHT COMFORT PRIVILEGE	HEIGHT COMFORT PRIVILEGE DOGA	HEIGHT COMFORT FAST	HEIGHT COMFORT FAST DOGA
182	160x195x17	✓	✗	✓	✗
162	140x195x17	✓	✗	✓	✗
142	120x195x17	✓	✗	✓	✗
122	100x195x17	✓	✗	✓	✗
92	70x195x17	✓	✗	✓	✗



Anallergico
Antibacterial - anti mite



Tessuto stretch
Stretch fabric



Fascia traspirante 3D
3D breathable band



I Materassi sono disponibili anche nelle versioni ignifughe CLASSE 1 IM - BS 7177 - 16 CFR 1632 e 16 CFR 1633



Anallergico
Antibacterial - anti mite



Tessuto stretch
Stretch fabric



Alta densità
High density



Memory foam
Confort memory

Materasso H16 Height Comfort D30 Memory

Con i suoi 16 cm H il Materasso Height Comfort Memory D30 si colloca nella fascia di materassi da letto e grazie alla sua struttura combinata in Memory Foam e Poliuretano, garantisce una maggiore ergonomia donando un comfort incomparabile. Rivestito con tessuto stretch anallergico e design moderno.

Mattress H16 Height Comfort D30 Memory is considered a real bed mattress. The combination of Memory Foam and Polyurethane ensures the maximum expression of ergonomic and comfort. Covered with a stylish and hypoallergenic stretch fabric.

misure meccanismo (cm)	dimensione materasso (cm)	HEIGHT COMFORT PRIVILEGE	HEIGHT COMFORT PRIVILEGE DOGA	HEIGHT COMFORT FAST	HEIGHT COMFORT FAST DOGA
182	160x195x16	✓	✓	✓	✓
162	140x195x16	✓	✓	✓	✓
142	120x195x16	✓	✓	✓	✓
122	100x195x16	✓	✓	✓	✓
92	70x195x16	✓	✓	✓	✓

Materasso H16 Height Comfort D30 Stretch

Con i suoi 16 cm H il Materasso Height Comfort D30 Stretch ad alta densità si colloca nella fascia di materassi da letto assicurandone massimo comfort. Rivestito con tessuto stretch anallergico e fascia traspirante 3D.

Mattress H16 Height Comfort D30 Stretch is considered a real bed mattress, ensuring the maximum expression of comfort. Covered with an hypoallergenic stretch fabric.

misure meccanismo (cm)	dimensione materasso (cm)	HEIGHT COMFORT PRIVILEGE	HEIGHT COMFORT PRIVILEGE DOGA	HEIGHT COMFORT FAST	HEIGHT COMFORT FAST DOGA
182	160x195x16	✓	✓	✓	✓
162	140x195x16	✓	✓	✓	✓
142	120x195x16	✓	✓	✓	✓
122	100x195x16	✓	✓	✓	✓
92	70x195x16	✓	✓	✓	✓



Anallergico
Antibacterial - anti mite



Tessuto stretch
Stretch fabric



Alta densità
High density



Fascia traspirante 3D
3D breathable band

Disponibile anche nella versione TNT
Also available with TNT cover



I Materassi sono disponibili anche nelle versioni ignifughe CLASSE 1 IM - BS 7177 - 16 CFR 1632 e 16 CFR 1633

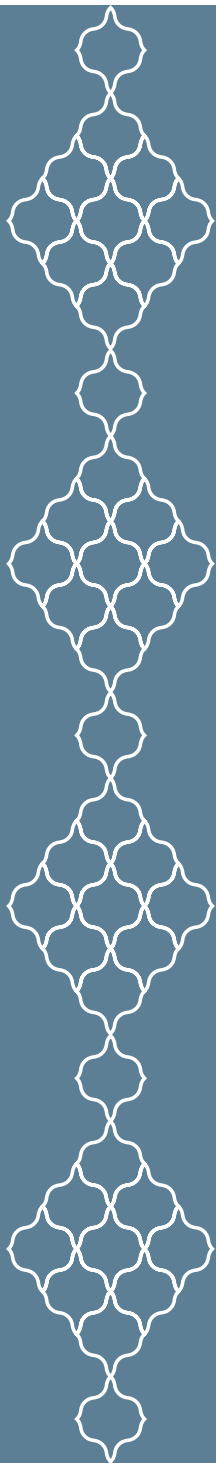
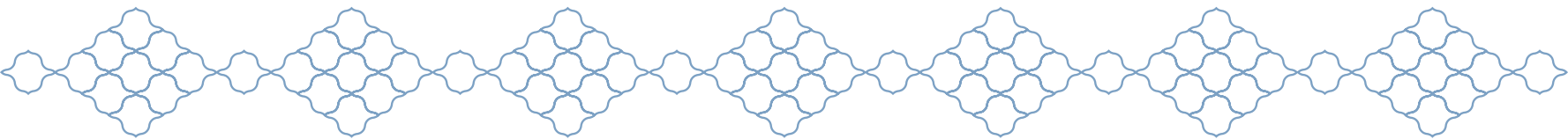

SERIE
M14



**MECCANISMI
A RIBALTA**

REVOLVING
MECHANISMS

altaflex
sofa bed mechanisms



WWW.ALTALEX.IT





Mec Plus+ M14

Meccanismo a ribalta con sistema relax

Il meccanismo Mec Plus+ M14 è un sistema innovativo che permette di realizzare il primo divano letto con sistema integrato RELAX.

Il sistema RELAX è stato attentamente progettato e studiato per garantire la massima comodità e funzionalità di una poltrona con sollevamento della pediera, pur garantendo l'uso a divano-letto. L'apertura del meccanismo a ribalta è possibile senza rimuovere i cuscini dalla seduta e dallo schienale. Telaio in tubo da mobilio ad alta resistenza con verniciatura epossidica.

Il piano dormita è con rete in acciaio elettrosaldato e cinghie elastiche che rendono confortevole il momento del riposo.

Mec Plus+ M14 is an innovative integrated system for the 1st bed sofa with Relax integrated system. This system has been designed and studied to ensure the comfort of an armchair with attached footboard lifting integrated system guaranteeing as well as the use of a sofa bed.

Seat and back cushions are fixed to the frame during the opening action. High resistance frame in epoxy painted furniture.

The sleeping surface with an electro-welded steel mesh and elastic belts ensure a comfortable rest.

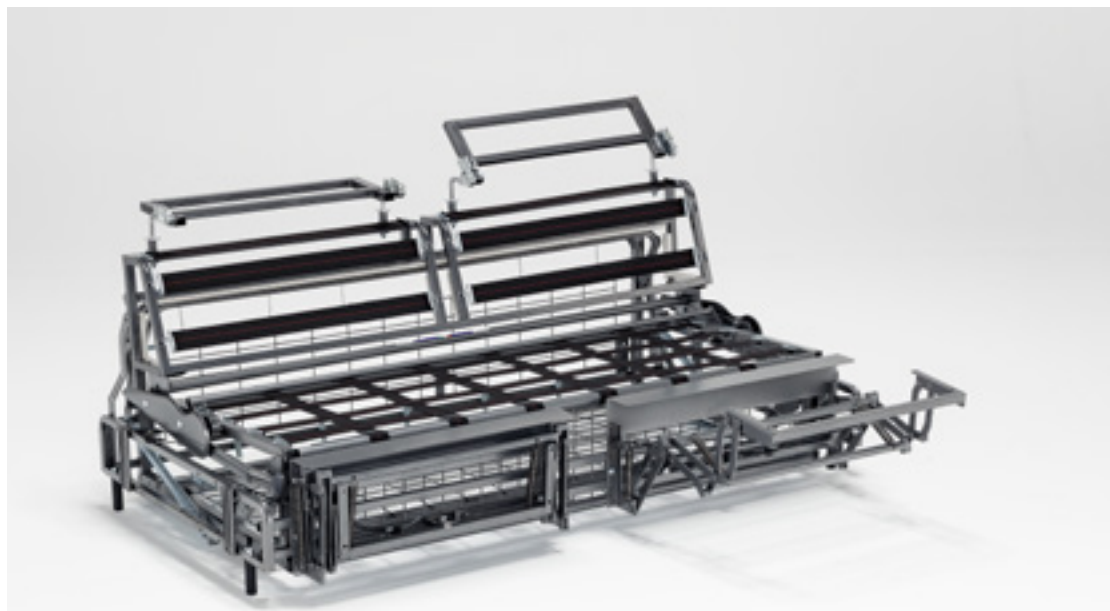

- Realizzato con spalliera poggiatesta
Mechanisms equipped with back headrests



Meccanismo a ribalta con sistema RELAX
Revolving mechanism with RELAX integrated system

ARTICOLO	A	B	DIMENSIONI consigliate del MATERASSO
Mec 125 MEC PLUS+ 182	182	165	160x196x14
Mec 125 MEC PLUS+ 162	162	145	140x196x14
Mec 125 MEC PLUS+ 142	142	125	120x196x14
Mec 125 MEC PLUS+ 122	122	105	100x196x14
Mec 125 MEC PLUS+ 92	92	75	70x196x14

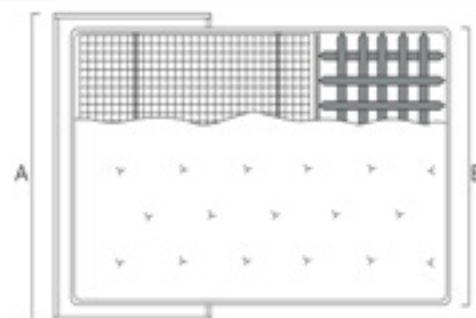
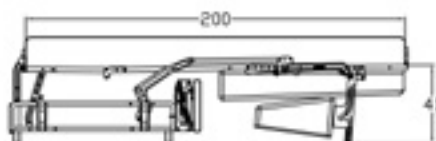
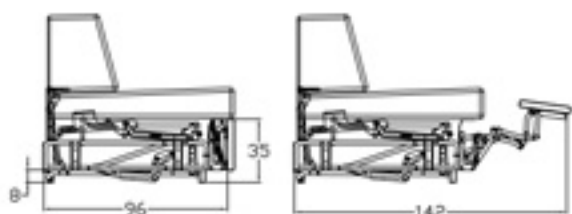

Progettato per la realizzazione di modelli
dal design moderno
It has been designed for the realization
of a modern design

SERIE M14



New Roller

Meccanismo a ribalta

Meccanismo a ribalta con sistema di apertura semplice ed unico, che consente di non rimuovere i cuscini della seduta e dello schienale del divano. Il meccanismo è fornito con innesti a baionetta che facilita il montaggio e smontaggio (braccioli, schienale, fascia) del divano, risolvendo il problema della movimentazione durante il trasporto. Telaio in tubo da mobilio ad alta resistenza con verniciatura epossidica. Piano dormita con rete in acciaio elettrosaldato e cinghie elastiche.

An insertion mechanism with a simple, single opening system that makes it possible to leave the seat and back cushions in place on the sofa. The mechanism has bayonet joints that make assembly and disassembly of the sofa (armrests, back, front panel) easier and which solve handling problems during transport. Ultra-strong frame in furniture tubing painted with epoxy powders. Sleeping surface with base in fuse-bonded steel and elastic straps.



- Meccanismo accessorato con portaguanciale doppio
Mechanism equipped with a double pillow storage

Articolo	A	B	DIMENSIONI consigliate del MATERASSO
Mec 106 New Roller 182	182	165	160x196x14
Mec 106 New Roller 162	162	145	140x196x14
Mec 106 New Roller 142	142	125	120x196x14
Mec 106 New Roller 122	122	105	100x196x14
Mec 106 New Roller 92	92	75	70x196x14

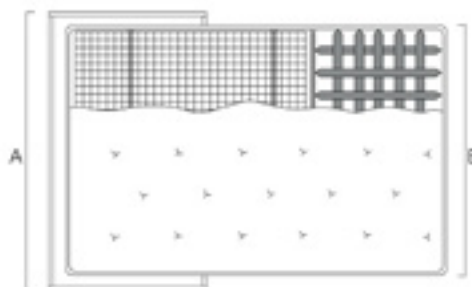
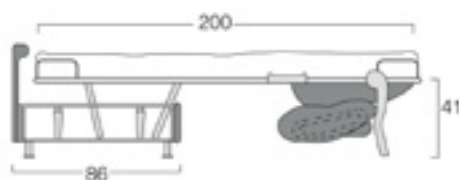



- Particolare piede dal design raffinato
Refined foot design

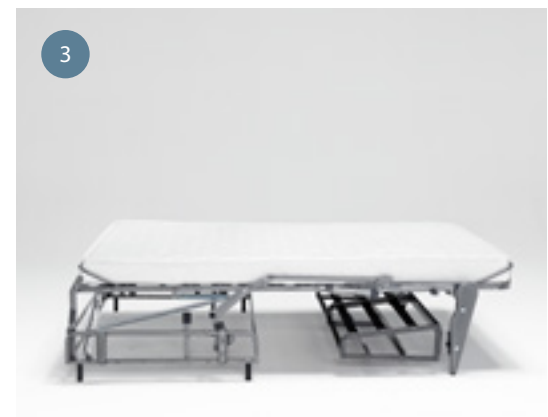

New Roller Doga

Meccanismo a ribalta con piano dormita a doghe con regolatori di rigidità

Innovativo sistema a ribalta, che con un semplice movimento consente l'apertura del meccanismo senza rimuovere i cuscini dalla seduta e dallo schienale. Il meccanismo New Roller Doga è fornito con innesti a baionetta che facilitano il montaggio e lo smontaggio (braccioli, schienale, fascia) del divano, risolvendo il problema della movimentazione durante il trasporto.

La New Roller Doga è fortemente consigliata per chi utilizza giornalmente il divano in modalità letto e necessita di un piano dormita altamente confortevole adattabile alle proprie esigenze, grazie alle 4 regolazioni effettuabili su ciascun posto in modo indipendente e semplice.

Il piano dormita utilizza doghe in legno (materiale green - ecocompatibile) di varie rigidità che determinano un piano dormita differenziato a zone e regolabile in modo semplice da qualsiasi utilizzatore.

Revolving mechanism New Roller with wooden slats with tension adjusters.

This clever revolving mechanism with a simple and unique opening system converts into a bed. Seat and back cushions are fixed to the frame during the opening action. New Roller with wooden slats is supplied with bayonet joints, that allow an easy assembly and disassembly operation (arm and backrests and components) for a simple handling of the sofa bed.

New Roller with wooden slats is made of two independent sleeping surfaces. It is dedicated to people who need a customized tension adjustment with its 4 levels.

The sleeping surface is made of WOODEN SLATS (GREEN- ECO-FRIENDLY) that have various tension levels for a differentiated and adjustable sleeping surface.



- Meccanismo accessoriato con portaguanciaie doppio
Mechanism equipped with a double pillow storage

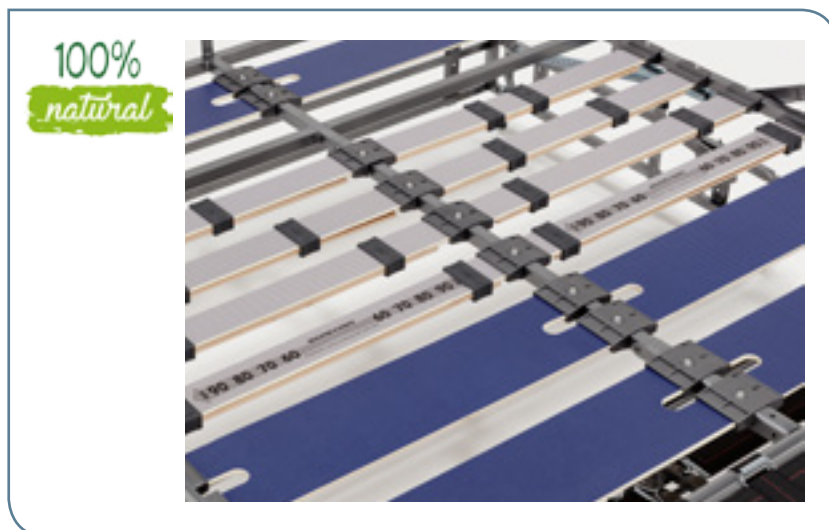

- Piano dormita a doghe con rigidità regolabile
Wooden slats surface with tension adjuster

ARTICOLO	A	B	DIMENSIONI consigliate del MATERASSO
Mec 106 NEW ROLLER 182	182	165	160x196x13
Mec 106 NEW ROLLER 162	162	145	140x196x13
Mec 106 NEW ROLLER 142	142	125	120x196x13
Mec 106 NEW ROLLER 122	122	105	100x196x13
Mec 106 NEW ROLLER 92	92	75	70x196x13

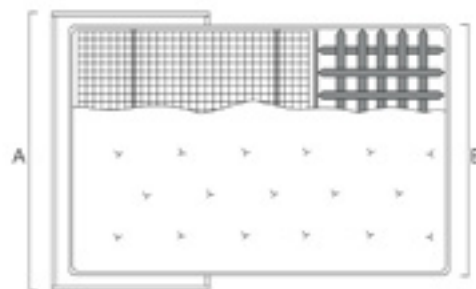
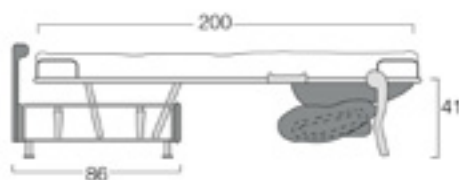

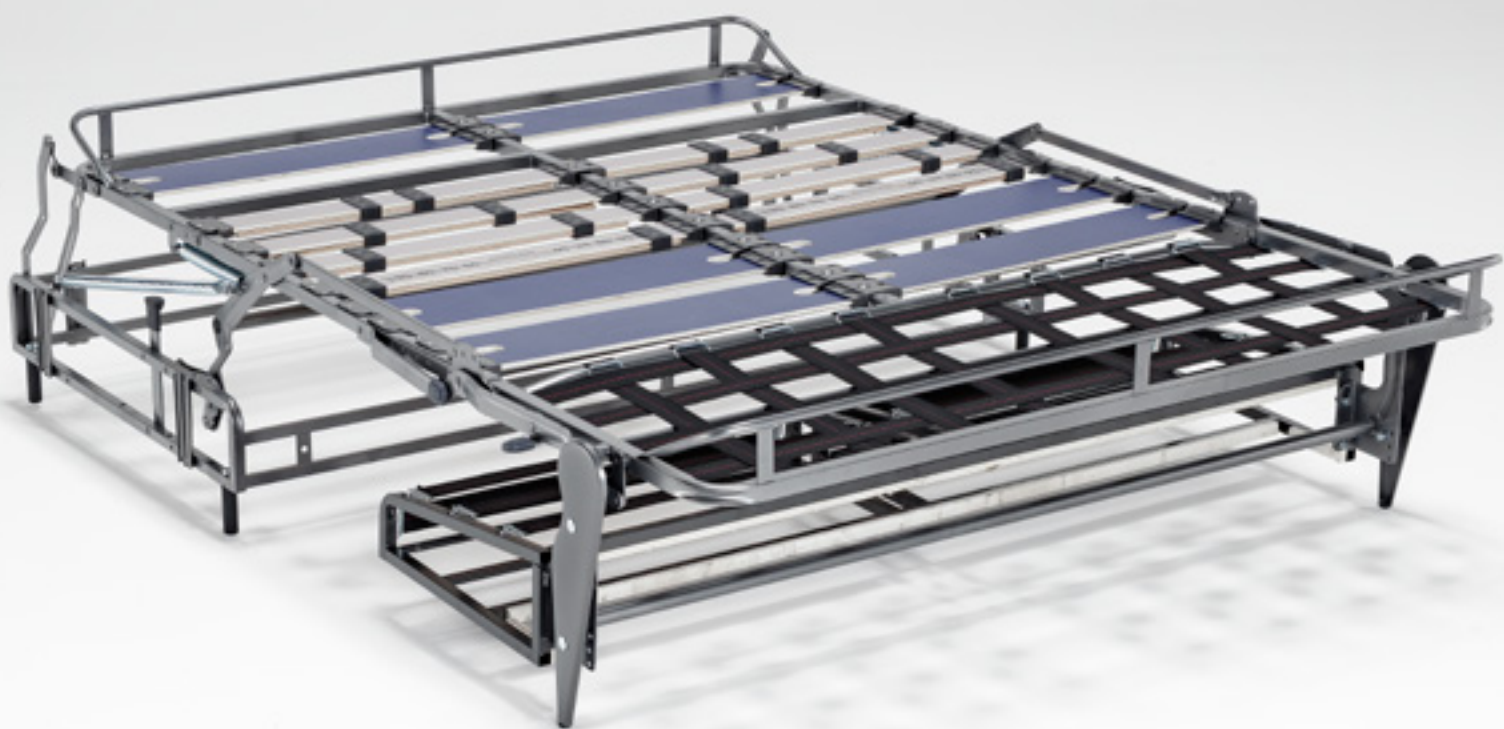

Meccanismo indicato per un uso quotidiano
Advised for daily use



Fast

Meccanismo a ribalta

Meccanismo a ribalta con sistema di apertura semplice ed unico, che consente di non rimuovere i cuscini della seduta e dello schienale del divano.

Il meccanismo è fornito con innesti a baionetta che facilita il montaggio e smontaggio (braccioli, schienale, fascia) del divano, risolvendo il problema della movimentazione durante il trasporto. Telaio in tubo da mobilio ad alta resistenza con verniciatura epossidica. Piano dormita con rete in acciaio elettrosaldato e cinghie elastiche.

An insertion mechanism with a simple, single opening system that makes it possible to leave the seat and back cushions in place on the sofa. The mechanism has bayonet joints that make assembly and disassembly of the sofa (armrests, back, front panel) easier and which solve handling problems during transport. Ultra-strong frame in furniture tubing painted with epoxy powders. Sleeping surface with base in fuse-bonded steel and elastic straps.



- Meccanismo accessoriato con portaguanciaie unico
Mechanism equipped with one pillow holder



ARTICOLO	A	B	DIMENSIONI consigliate del MATERASSO
Mec 119 Fast 182	182	165	160x196x14
Mec 119 Fast 162	162	145	140x196x14
Mec 119 Fast 142	142	125	120x196x14
Mec 119 Fast 122	122	105	100x196x14
Mec 119 Fast 92	92	75	70x196x14

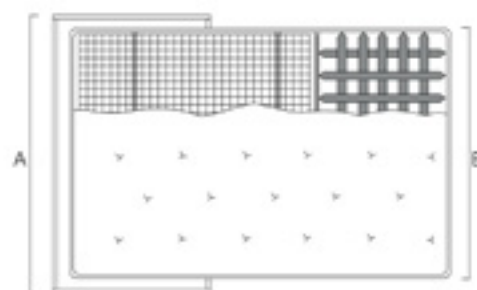
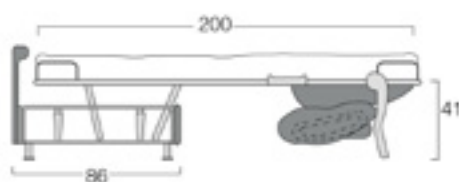

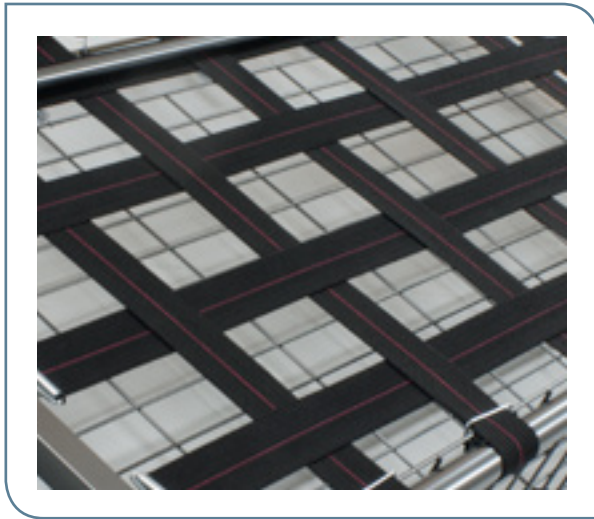

- Disponibile anche nella versione con seduta in cinghie elastiche
Also available with seat in elastic straps



- Disponibile anche con accessorio Carter ABS copri piede
Also available with ABS Carter footrest cover

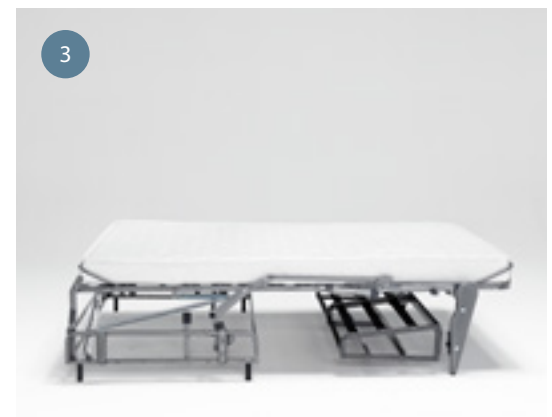
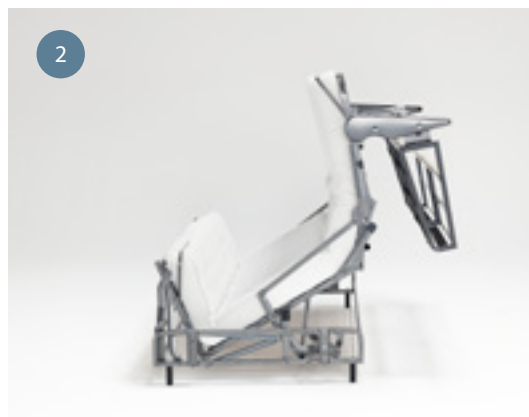

Fast Doga

Meccanismo a ribalta con piano dormita a doghe

Innovativo sistema a ribalta, che con un semplice movimento consente l'apertura del meccanismo senza rimuovere i cuscini dalla seduta e dallo schienale. Il meccanismo Fast Doga è fornito con innesti a baionetta che facilitano il montaggio e lo smontaggio (braccioli, schienale, fascia) del divano, risolvendo il problema della movimentazione durante il trasporto.

La Fast Doga è fortemente consigliata per chi utilizza giornalmente il divano in modalità letto e necessita di un piano dormita altamente confortevole ed ergonomico. Il piano dormita utilizza doghe in legno (materiale green - ecocompatibile) che rendono il piano dormita ortopedico.

This clever revolving mechanism with a simple and unique opening system converts into a bed. Seat and back cushions are fixed to the frame during the opening action. Fast with wooden slats is supplied with bayonet joints, that allow easy assembly and disassembly operation (arm and backrests and components) for a simple handling of the sofa bed.

Fast with wooden slats is highly recommended for a daily domestic use, because of its ergonomic and comfortable sleeping surface.

The sleeping surface made of wooden slats (green - eco friendly) ensures an orthopedic support.



- Meccanismo accessoriato con portaganciale unico
Mechanism equipped with one pillow holder



ARTICOLO	A	B	DIMENSIONI consigliata del MATERASSO
Mec 119 FAST 182	182	165	160x196x13
Mec 119 FAST 162	162	145	140x196x13
Mec 119 FAST 142	142	125	120x196x13
Mec 119 FAST 122	122	105	100x196x13
Mec 119 FAST 92	92	75	70x196x13

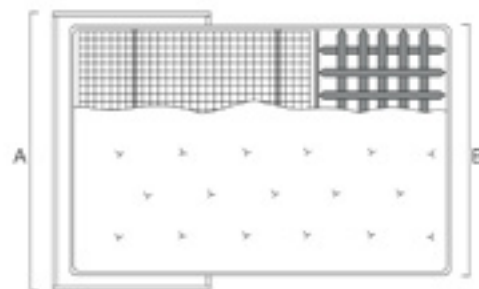
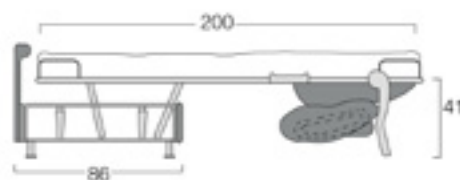



- Disponibile anche con accessorio Carter ABS copri piede
Also available with ABS Carter footrest cover

1



2



3



Smart Piede 13

Meccanismo a ribalta con piede altezza 13 cm

Meccanismo a ribalta con sistema di apertura semplice ed unico che consente di non rimuovere i cuscini dalla seduta e dello schienale. Progettato per la realizzazione di modelli con altezza piedi H 13 cm, per un design moderno.

Revolving mechanism with simple and single opening system that makes it possible to leave the seat and back cushions in place on the sofa. This item has been designed to manufacture sofa bed models with h13 legs in a modern style.



- Meccanismo accessoriato con spalliera standard
Mechanism equipped with standard backrest

ARTICOLO	A	B	DIMENSIONI consigliate del MATERASSO
Mec 111 Smart Piede 13	182	165	160x196x14
Mec 111 Smart Piede 13	162	145	140x196x14
Mec 111 Smart Piede 13	142	125	120x196x14
Mec 111 Smart Piede 13	122	105	100x196x14
Mec 111 Smart Piede 13	92	75	70x196x14

1



2



3

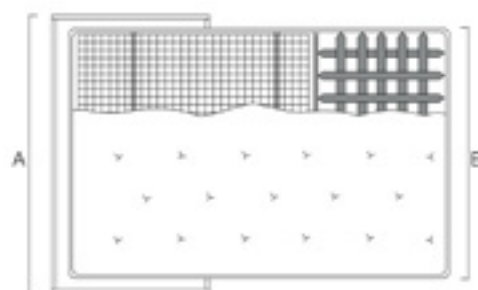
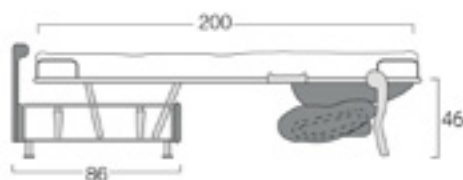



Progettato per la realizzazione di modelli con altezza piedi H 13 cm

This item has been designed to manufacture sofa bed models with H 13 legs



- Staffa blocco bracciolo
Armrest fixing bracket



- **Lift - Up H 13**
Accessorio utile per facilitare lo spostamento del divano e il montaggio del bracciolo
Designed to move easily the sofa bed inside the room.
To simplify the assembly of the armrest

Smart Piede 13 Doga

Meccanismo a ribalta con piano dormita a doghe

Innovativo sistema a ribalta, che con un semplice movimento consente l'apertura del meccanismo senza rimuovere i cuscini dalla seduta e dallo schienale. Il meccanismo Smart Piede 13 Doga è progettato per la realizzazione di modelli divani con altezza piedi H 13 cm per un design moderno. Inoltre è fornito con innesti a baionetta che facilitano il montaggio e lo smontaggio (braccioli, schienale, fascia) del divano, risolvendo il problema della movimentazione durante il trasporto.

La Smart Piede 13 Doga è fortemente consigliata per chi utilizza giornalmente il divano in modalità letto e necessita di un piano dormita altamente confortevole ed ergonomico. Il piano dormita utilizza doghe in legno (materiale green - ecocompatibile) che rendono il piano dormita ortopedico.

This clever revolving mechanism with a simple and unique opening system converts into a bed. Seat and back cushions are fixed to the frame during the opening action.

The Smart Leg 13 has been designed for the manufacturing of more comfortable and modern upholstered sofa beds sofas with 13 cm high legs.



● Meccanismo accessoriato con spalliera standard
Mechanism equipped with standard backrest



ARTICOLO	A	B	DIMENSIONI consigliate del MATERASSO
Mec 111 SMART PIEDE 13 182	182	165	160x196x13
Mec 111 SMART PIEDE 13 162	162	145	140x196x13
Mec 111 SMART PIEDE 13 142	142	125	120x196x13
Mec 111 SMART PIEDE 13 122	122	105	100x196x13
Mec 111 SMART PIEDE 13 92	92	75	70x196x13

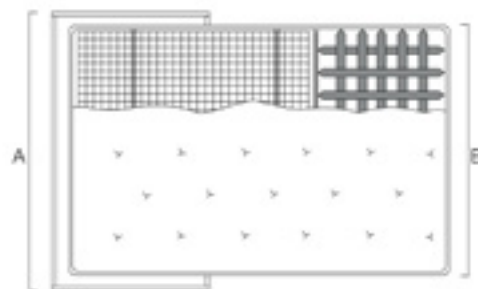
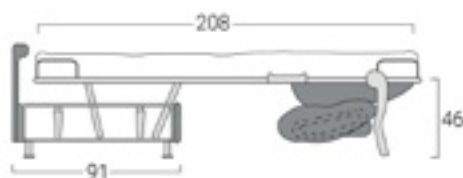



● Staffa blocco bracciolo
Armrest fixing bracket

1



2



3



Materassi

Mec Plus+ M14 - Roller - Fast - Smart Piede 13



Anallergico
Antibacterial - anti mite

Materasso H12 Roller in cotone

Materasso in poliuretano di bassadensità rivestito con tessuto in poly-cotone losangato solo da un lato.

Mattress in polyurethane low density, covered with Quilted poly-cotton fabric and with anti-dust mite treatment.

misure meccanismo (cm)	dimensione materasso (cm)	MEC PLUS+ M14	NEW ROLLER	NEW ROLLER DOGA	FAST	FAST DOGA	SMART PIEDE 13	SMART PIEDE 13 DOGA
182	160x196x12	✓	✓	✓	✓	✓	✓	✓
162	140x196x12	✓	✓	✓	✓	✓	✓	✓
142	120x196x12	✓	✓	✓	✓	✓	✓	✓
122	100x196x12	✓	✓	✓	✓	✓	✓	✓
92	70x196x12	✓	✓	✓	✓	✓	✓	✓

Materasso H13 Roller D30 Stretch Sfoderabile

Materasso in poliuretano di media densità rivestito con tessuto stretch anallergico sfoderabile.

Mattress in polyurethane with medium density, removable cover with stretch fabric and antibacterial - anti mite treatment.



Anallergico
Antibacterial - anti mite



Sfoderabile
Removable cover



Tessuto stretch
Stretch fabric



Lavaggio a secco
Dry cleaning



misure meccanismo (cm)	dimensione materasso (cm)	MEC PLUS+ M14	NEW ROLLER	NEW ROLLER DOGA	FAST	FAST DOGA	SMART PIEDE 13	SMART PIEDE 13 DOGA
182	160x196x12	✓	✓	✓	✓	✓	✓	✓
162	140x196x12	✓	✓	✓	✓	✓	✓	✓
142	120x196x12	✓	✓	✓	✓	✓	✓	✓
122	100x196x12	✓	✓	✓	✓	✓	✓	✓
92	70x196x12	✓	✓	✓	✓	✓	✓	✓



I Materassi sono disponibili anche nelle versioni ignifughe CLASSE 1 IM - BS 7177 - 16 CFR 1632 e 16 CFR 1633



Anallergico
Antibacterial - anti mite



Tessuto stretch
Stretch fabric



Fascia traspirante 3D
3D breathable band

Materasso H13 Roller D25 Stretch

Materasso in poliuretano di media densità rivestito con tessuto stretch anallergico e fascia traspirante 3D

Mattress in polyurethane with medium density, covered with stretch fabric and antibacterial - anti mite treatment and 3D breathable band.

misure meccanismo (cm)	dimensione materasso (cm)	MEC PLUS+ M14	NEW ROLLER	NEW ROLLER DOGA	FAST	FAST DOGA	SMART PIEDE 13	SMART PIEDE 13 DOGA
182	160x196x13	✓	✓	✓	✓	✓	✓	✓
162	140x196x13	✓	✓	✓	✓	✓	✓	✓
142	120x196x13	✓	✓	✓	✓	✓	✓	✓
122	100x196x13	✓	✓	✓	✓	✓	✓	✓
92	70x196x13	✓	✓	✓	✓	✓	✓	✓

Materasso H13 Roller D30 Stretch

Materasso in poliuretano di alta densità rivestito con tessuto stretch anallergico e fascia traspirante 3D.

Mattress in polyurethane with high density, covered with stretch fabric and antibacterial - anti mite treatment and 3D breathable band.



Anallergico
Antibacterial - anti mite



Tessuto stretch
Stretch fabric



Fascia traspirante 3D
3D breathable band



misure meccanismo (cm)	dimensione materasso (cm)	MEC PLUS+ M14	NEW ROLLER	NEW ROLLER DOGA	FAST	FAST DOGA	SMART PIEDE 13	SMART PIEDE 13 DOGA
182	160x196x13	✓	✓	✓	✓	✓	✓	✓
162	140x196x13	✓	✓	✓	✓	✓	✓	✓
142	120x196x13	✓	✓	✓	✓	✓	✓	✓
122	100x196x13	✓	✓	✓	✓	✓	✓	✓
92	70x196x13	✓	✓	✓	✓	✓	✓	✓



I Materassi sono disponibili anche nelle versioni ignifughe CLASSE 1 IM - BS 7177 - 16 CFR 1632 e 16 CFR 1633

Materassi

Mec Plus+ M14 - Roller - Fast - Smart Piede 13



Anallergico
Antibacterial - anti mite



Materiale a memoria
Confort memory



Tessuto stretch
Stretch fabric



Fascia traspirante 3D
3D breathable band

Materasso H13 Roller D30 Memory

Materasso in Memory Foam che garantisce un comfort ottimale al momento del riposo. Rivestito in tessuto stretch anallergico e fascia traspirante 3D.

Memory foam mattress it guarantees a good comfort for your rest. Mattress covered with antibacterial - anti mite treatment and 3D breathable band.

misure meccanismo (cm)	dimensione materasso (cm)	MEC PLUS+ M14	NEW ROLLER	NEW ROLLER DOGA	FAST	FAST DOGA	SMART PIEDE 13	SMART PIEDE 13 DOGA
182	160x196x13	✓	✓	✓	✓	✓	✓	✓
162	140x196x13	✓	✓	✓	✓	✓	✓	✓
142	120x196x13	✓	✓	✓	✓	✓	✓	✓
122	100x196x13	✓	✓	✓	✓	✓	✓	✓
92	70x196x13	✓	✓	✓	✓	✓	✓	✓



Anallergico
Antibacterial - anti mite



Memory foam
Confort memory



Alta densità
High density



Lavaggio a secco
Dry cleaning

Materasso H13 Topper D35 Memory

Materasso con supporto in poliuretano ad altissima resilienza e con Topper trapuntato con Memory Foam. Questo sistema rende il materasso comodo e di alta qualità. Rivestito con tessuto stretch anallergico.

Mattress with high resilience and Polyurethane core with Memory foam and quilted topper. This system makes the quality of this mattress very high. Mattress covered with antibacterial - anti mite treatment.



misure meccanismo (cm)	dimensione materasso (cm)	MEC PLUS+ M14	NEW ROLLER	NEW ROLLER DOGA	FAST	FAST DOGA	SMART PIEDE 13	SMART PIEDE 13 DOGA
182	160x196x13	✓	✓	✓	✓	✓	✓	✓
162	140x196x13	✓	✓	✓	✓	✓	✓	✓
142	120x196x13	✓	✓	✓	✓	✓	✓	✓
122	100x196x13	✓	✓	✓	✓	✓	✓	✓
92	70x196x13	✓	✓	✓	✓	✓	✓	✓



I Materassi sono disponibili anche nelle versioni ignifughe CLASSE 1 IM - BS 7177 - 16 CFR 1632 e 16 CFR 1633



Materasso H14 Roller D35 Memory

Il Materasso H14 Roller D35 Memory grazie alla sua struttura combinata in Memory Foam e Poliuretano ad altissima densità e con una bassa percentuale di deformazione, garantisce una maggiore ergonomicità donando un comfort incomparabile. È consigliato per chi necessita di un letto più accogliente e ben sostenuto. Rivestito con tessuto stretch e design innovativo e moderno.

Mattress H14 Roller D35 Memory is considered a real bed mattress. The combination of Memory Foam and Polyurethane ensures the maximum expression of ergonomic and comfort. Covered with a stylish and hypoallergenic stretch fabric.



Anallergico
Antibacterial - anti mite



Tessuto stretch
Stretch fabric



Alta densità
High density



Materiale a memoria
Confort memory

misure meccanismo (cm)	dimensione materasso (cm)	MEC PLUS+ M14	NEW ROLLER	NEW ROLLER DOGA	FAST	FAST DOGA	SMART PIEDE 13	SMART PIEDE 13 DOGA
182	160x196x14	✓	✓	✗	✓	✗	✓	✗
162	140x196x14	✓	✓	✗	✓	✗	✓	✗
142	120x196x14	✓	✓	✗	✓	✗	✓	✗
122	100x196x14	✓	✓	✗	✓	✗	✓	✗
92	70x196x14	✓	✓	✗	✓	✗	✓	✗

Materasso H 14 Roller Molle Indipendenti

Il Materasso H14 Roller Molle Indipendenti D30 è realizzato per adattarsi alla naturale forma della colonna vertebrale e sostenere il corpo nella giusta misura, prevenendo mal di schiena, indolenzimento dei muscoli e spossatezza. Rivestito con tessuto stretch anallergico, fascia traspirante 3D e con struttura costituita da circa 700 molle insacchettate indipendenti.

Mattress H14 Roller Independent Springs is made to adapt to the natural shape of the spine, to support the body in the right measure, prevent back pain, muscle soreness and exhaustion. With its 700 independent springs this mattress is covered with hypoallergenic and stretch fabric guaranteeing the support of a spring surface and a pleasant contact with the body.



Anallergico
Antibacterial - anti mite



Tessuto stretch
Stretch fabric



Alta densità
High density



Fascia traspirante 3D
3D breathable band



misure meccanismo (cm)	dimensione materasso (cm)	MEC PLUS+ M14	NEW ROLLER	NEW ROLLER DOGA	FAST	FAST DOGA	SMART PIEDE 13	SMART PIEDE 13 DOGA
182	160x196x14	✓	✓	✗	✓	✗	✓	✗
162	140x196x14	✓	✓	✗	✓	✗	✓	✗
142	120x196x14	✓	✓	✗	✓	✗	✓	✗
122	100x196x14	✓	✓	✗	✓	✗	✓	✗
92	70x196x14	✓	✓	✗	✓	✗	✓	✗



I Materassi sono disponibili anche nelle versioni ignifughe CLASSE 1 IM - BS 7177 - 16 CFR 1632 e 16 CFR 1633

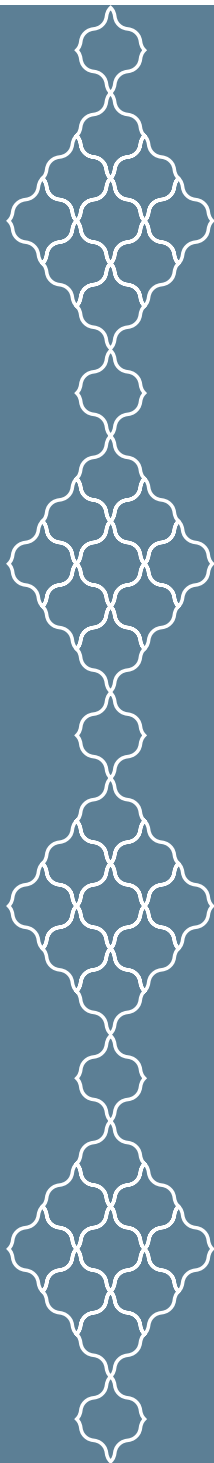
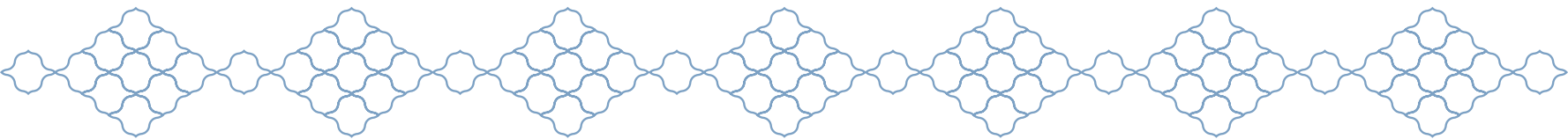

SERIE EXTRA



MECCANISMI
A RIBALTA

REVOLVING
MECHANISMS

altaflex
sofa bed mechanisms



WWW.ALTALEX.IT





Extra Smart Piede 8

Meccanismo a ribalta con piano dormita da 208 cm

Meccanismo a ribalta con sistema di apertura semplice ed unico, che consente di non rimuovere i cuscini della seduta e dello schienale del divano. L'extra smart piede 8 grazie alla sua profondità maggiore della seduta e alla ridotta fascia frontale, permette la realizzazione di divani più confortevoli e moderni. Inoltre il meccanismo è dotato di un piano dormita per alloggiare un materasso di 208 cm. Telaio in tubo da mobilio ad alta resistenza con verniciatura epossidica. Piano dormita con rete in acciaio elettrosaldato e cinghie elastiche.

An insertion mechanism with a simple, single opening system that makes it possible to leave the seat and back cushions in place on the sofa. Mec extra-smart leg 8 thanks to its greater depth of the seat and to the reduced front panel, it allows a more comfortable and modern sofa design. This mechanism also has a sleeping surface with 208 cm long mattress.

Ultra-strong frame in furniture tubing painted with epoxy powders. Sleeping surface with base in fuse-bonded steel and elastic straps.



● Meccanismo accessoriato con spalliera poggiatesta
Mechanisms equipped with back headrests

Articolo	A	B	DIMENSIONI consigliate del MATERASSO
Mec 111 Extra Smart 182	182	165	160x208x12
Mec 111 Extra Smart 162	162	145	140x208x12
Mec 111 Extra Smart 142	142	125	120x208x12
Mec 111 Extra Smart 122	122	105	100x208x12
Mec 111 Extra Smart 92	92	75	70x208x12

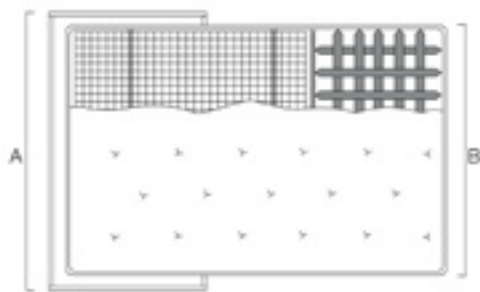
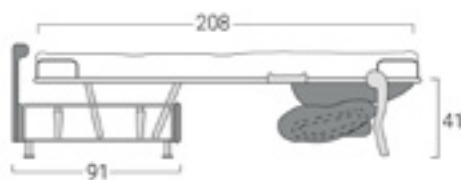
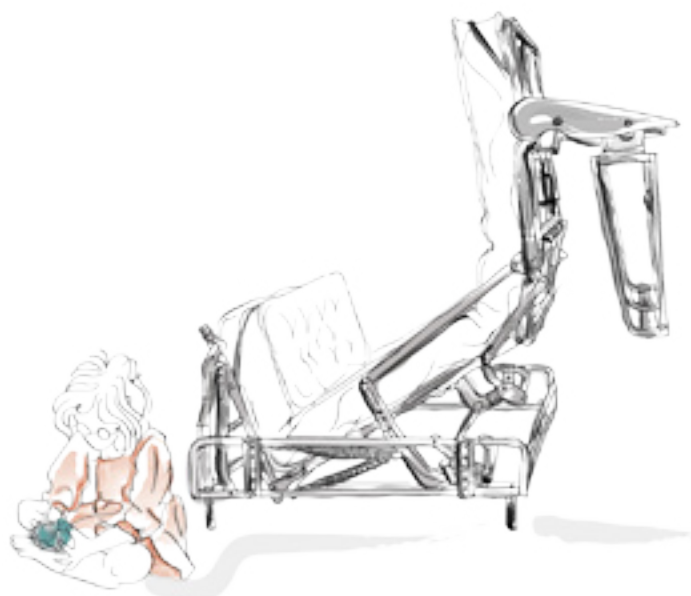



● Lunghezza piano dormita 208 cm
The sleeping surface is 208 cm long

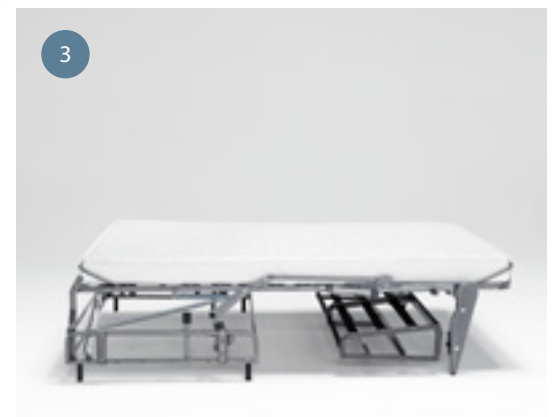
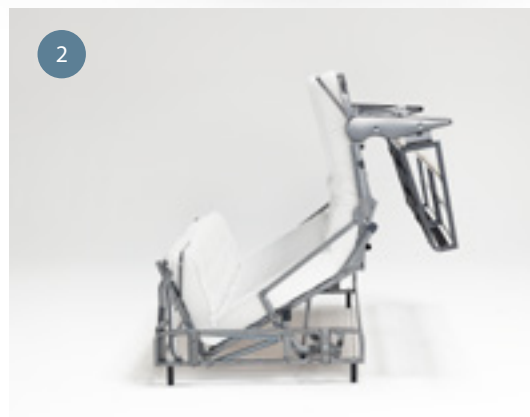

Extra Smart Piede 8 Doga

Meccanismo a ribalta con piano dormita a doghe da 208 cm

Innovativo sistema a ribalta, che con un semplice movimento consente l'apertura del meccanismo senza rimuovere i cuscini dalla seduta e dallo schienale. L' Extra Smart Piede 8 Doga, grazie alla sua profondità maggiore della seduta e alla ridotta fascia frontale, permette la realizzazione di divani più confortevoli e moderni. Inoltre il meccanismo è dotato di un piano dormita per alloggiare un materasso di 208 cm. Telaio in tubo da mobilio ad alta resistenza con verniciatura epossidica.

Il piano dormita utilizza doghe in legno (materiale green - ecocompatibile) che rendono il piano dormita ortopedico e utilizzabile per uso frequente.

This clever revolving mechanism with a simple and unique opening system converts into a bed. Seat and back cushions are fixed to the frame during the opening action.

Extra Smart Leg 8 with wooden slats is available to accommodate a mattress 208 cm.

The sleeping surface made of wooden slats (green - eco friendly) ensures an orthopedic support for a daily domestic use.



- Meccanismo accessoriato con spalliera poggiatesta
Mechanisms equipped with back headrests

ARTICOLO	A	B	DIMENSIONI consigliate del MATERASSO
Mec 111 EXTRA SMART 182	182	165	160x208x12
Mec 111 EXTRA SMART 162	162	145	140x208x12
Mec 111 EXTRA SMART 142	142	125	120x208x12
Mec 111 EXTRA SMART 122	122	105	100x208x12
Mec 111 EXTRA SMART 92	92	75	70x208x12

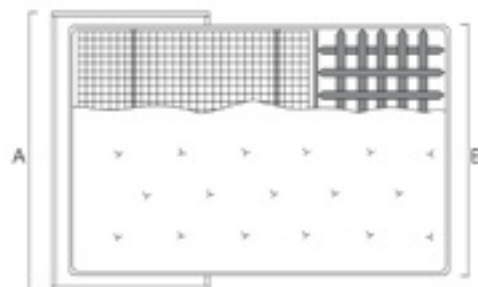
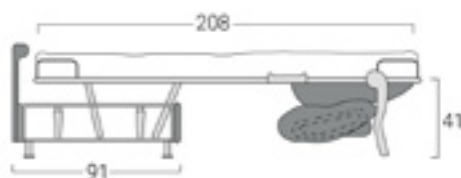

- Lunghezza piano dormita 208 cm
The sleeping surface is 208 cm long

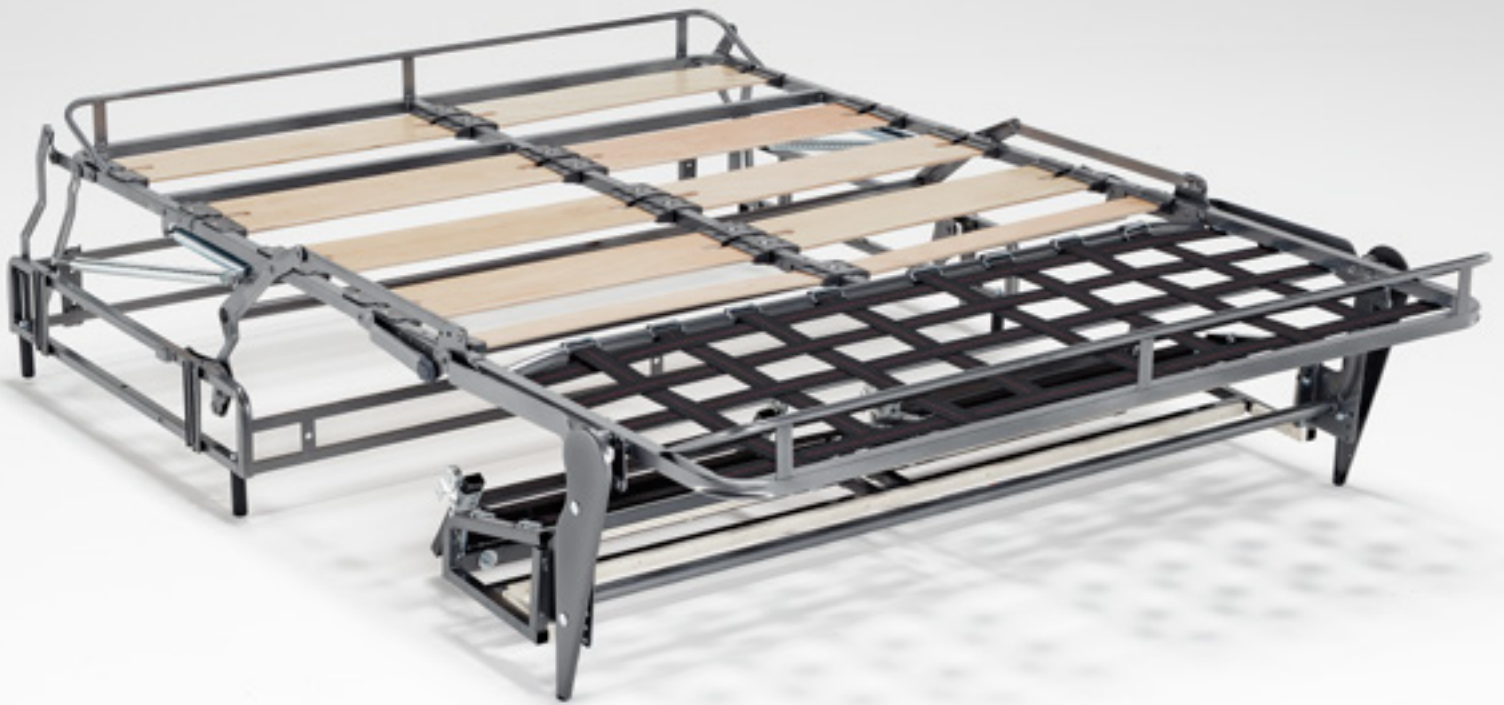

Meccanismo indicato per un uso quotidiano
Advised for daily use

1



2



3



Extra Smart Piede 13

Meccanismo a ribalta con piede altezza 13 cm e piano dormita da 208 cm

Meccanismo a ribalta con sistema di apertura semplice ed unico che consente di non rimuovere i cuscini dalla seduta. Progettato per la realizzazione di modelli con altezza piedi H 13 cm, per un design moderno. Lunghezza piano dormita di 208 cm.

Revolving mechanism with simple and single opening system that makes it possible to leave the seat and back cushions in place on the sofa. It has been designed to manufacture sofa beds with h13 legs in a modern style. The sleeping surface is 208 cm long.



● Realizzato con spalliera poggiatesta
Mechanisms equipped with back headrests

Meccanismo da inserimento con sistema di apertura semplice ed unico

Revolving mechanism with simple and single opening system



ARTICOLO	A	B	DIMENSIONI consigliate del MATERASSO
Mec 111 Extra Smart Piede13	182	165	160x208x12
Mec 111 Extra Smart Piede13	162	145	140x208x12
Mec 111 Extra Smart Piede13	142	125	120x208x12
Mec 111 Extra Smart Piede13	122	105	100x208x12
Mec 111 Extra Smart Piede13	92	75	70x208x12

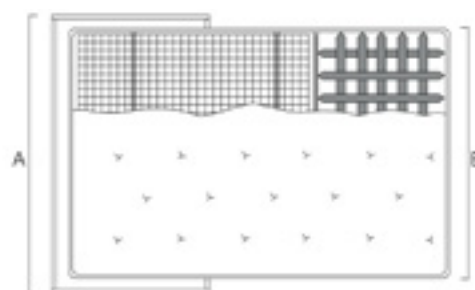
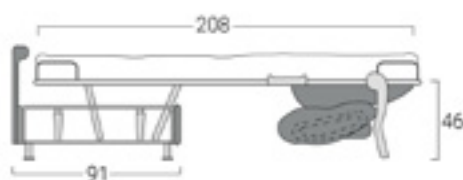

Progettato per la realizzazione di modelli
dal design moderno
It has been designed for the realization
of a modern design

SERIE EXTRA



- Lunghezza piano dormita di 208 cm
The sleeping surface is 208 cm long



- Staffa blocco bracciolo
Armrest fixing bracket



Extra smart Piede 13 Doga

Meccanismo a ribalta con piano dormita a doghe da 208 cm

Innovativo sistema a ribalta, che con un semplice movimento consente l'apertura del meccanismo senza rimuovere i cuscini dalla seduta e dallo schienale. L' Extra Smart Piede 13 Doga grazie alla sua profondità maggiore della seduta e alla ridotta fascia frontale e all'altezza del piede 13 cm, permette la realizzazione di divani più confortevoli e moderni. Inoltre il meccanismo è dotato di un piano dormita per alloggiare un materasso di 208 cm. Telaio in tubo da mobilio ad alta resistenza con verniciatura epossidica.

Il piano dormita utilizza doghe in legno (materiale green - ecocompatibile) che rendono il piano dormita ortopedico e utilizzabile per uso frequente.

This clever revolving mechanism with a simple and unique opening system converts into a bed. Seat and back cushions are fixed to the frame.

The Extra Smart Leg 13 with wooden slats thanks to its greater depth of the seat to the reduced frontal band and to the height of the foot 13 cm, allows the realization of more comfortable and modern sofas.

The Extra Smart Leg 13 with wooden slats is available to accommodate a mattress 2.08 m.

The sleeping surface made of wooden slats (green - eco friendly) ensures an orthopedic support for a daily domestic use.



- Realizzato con spalliera poggiatesta
Mechanisms equipped with back headrests



ARTICOLO	A	B	DIMENSIONI consigliate del MATERASSO
Mec 111 EXTRA SMART 182	182	165	160x208x12
Mec 111 EXTRA SMART 162	162	145	140x208x12
Mec 111 EXTRA SMART 142	142	125	120x208x12
Mec 111 EXTRA SMART 122	122	105	100x208x12
Mec 111 EXTRA SMART 92	92	75	70x208x12

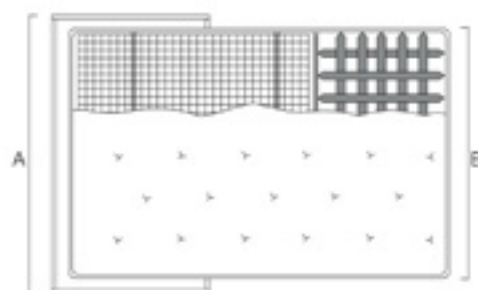
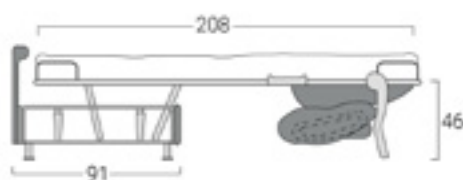

Progettato per la realizzazione di modelli
dal design moderno
It has been designed for the realization
of a modern design

SERIE EXTRA



- Lunghezza piano dormita di 208 cm
The sleeping surface is 208 cm long



- Staffa blocco bracciolo
Armrest fixing bracket

Meccanismo indicato per un uso quotidiano
Advised for daily use

1



2



3



Materassi per Extra Smart



Anallergico
Antibacterial - anti mite



Tessuto stretch
Stretch fabric



Alta densità
High density



Memory foam
Confort memory



Fascia traspirante 3D
3D breathable band

Materasso H12 Extra Smart D30 Memory

Il Materasso Extra Smart D30 Memory grazie alla sua lunghezza di 208 cm e alla sua struttura combinata in Memory Foam e Poliuretano, garantisce una maggiore ergonomicità donando un comfort incomparabile. È consigliato per chi necessita di un letto più accogliente in termini di lunghezza. Rivestito con tessuto stretch anallergico e fascia traspirante 3D.

Extra Smart D30 Memory Mattress H12 with its 208 cm length is considered a real bed mattress. The combination of Memory Foam and Polyurethane ensures the maximum expression of ergonomic and comfort. It is perfect for a domestic daily use of the sofa bed, guaranteeing the well-being of a real bed mattress. Covered with an hypoallergenic stretch fabric and 3D breathable band.

misure meccanismo (cm)	dimensione materasso (cm)	EXTRA SMART PIEDE 8	EXTRA SMART PIEDE 8 DOGA	EXTRA SMART PIEDE 13	EXTRA SMART PIEDE 13 DOGA
182	160x208x12	✓	✓	✓	✓
162	140x208x12	✓	✓	✓	✓
142	120x208x12	✓	✓	✓	✓
122	100x208x12	✓	✓	✓	✓
92	70x208x12	✓	✓	✓	✓



I Materassi sono disponibili anche nelle versioni ignifughe CLASSE 1 IM - BS 7177 - 16 CFR 1632 e 16 CFR 1633

Materasso H12 Extra Smart D30 Stretch

Il Materasso Extra Smart D30, grazie alla sua lunghezza di 208 cm e all'alta densità del Poliuretano, rende il piano dormita accogliente. È consigliato per chi necessita di un letto confortevole in termini di lunghezza. Rivestito con tessuto stretch anallergico e fascia traspirante 3D.

Extra Smart D30 Memory Mattress H12 with its 208 cm length and polyurethane with high density ensures an excellent sleeping surface. It is dedicated to people who need comfort in terms of lengths Covered with an hypoallergenic stretch fabric and 3D breathable band.



Anallergico
Antibacterial - anti mite



Tessuto stretch
Stretch fabric



Alta densità
High density



Fascia traspirante 3D
3D breathable band



misure meccanismo (cm)	dimensione materasso (cm)	EXTRA SMART PIEDE 8	EXTRA SMART PIEDE 8 DOGA	EXTRA SMART PIEDE 13	EXTRA SMART PIEDE 13 DOGA
182	160x208x12	✓	✓	✓	✓
162	140x208x12	✓	✓	✓	✓
142	120x208x12	✓	✓	✓	✓
122	100x208x12	✓	✓	✓	✓
92	70x208x12	✓	✓	✓	✓



I Materassi sono disponibili anche nelle versioni ignifughe CLASSE 1 IM - BS 7177 - 16 CFR 1632 e 16 CFR 1633

Penisola per New Roller/Fast

Penisola con piano di appoggio elettrosaldato, sollevabile tramite molle a gas, consentendo l'utilizzo di un contenitore.

Telaio in tubo da mobilio ad alta resistenza con verniciatura epossidica. Utilizzabile per i modelli new roller e fast.

The mechanism is equipped with a peninsula with fuse-bonded support surface that lifts up using gas springs, allowing the use of a storage container.

Ultra-strong frame in furniture tubing painted with epoxy powders, with high resistance. Only for New Roller and Fast.



ARTICOLO

Mec 106/P penisola New Roller/Fast

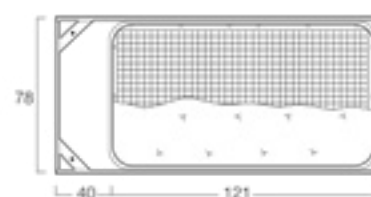
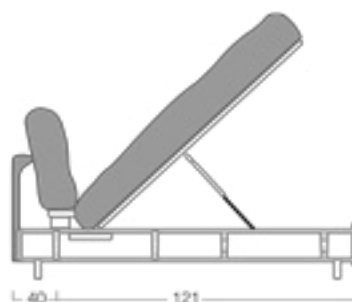
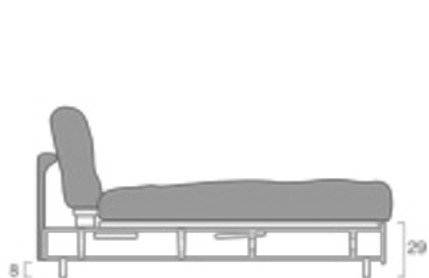



1



2



Accessori

per meccanismi a ribalta

Spalliera privilege

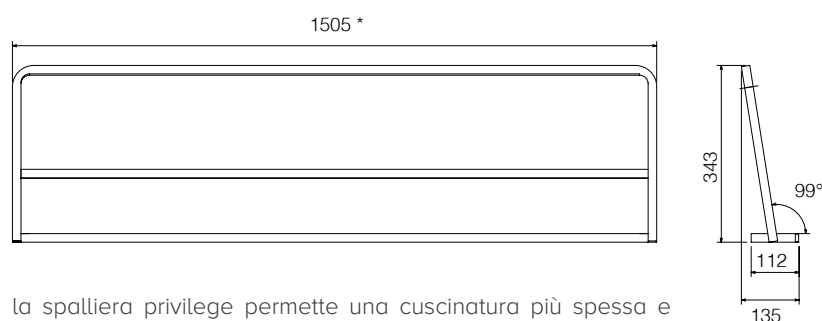

la spalliera privilege permette una cuscineria più spessa e diversificata per una maggiore comodità

the privilege back allowing a thicker and diversified filling for greater comfort

Spalliera standard

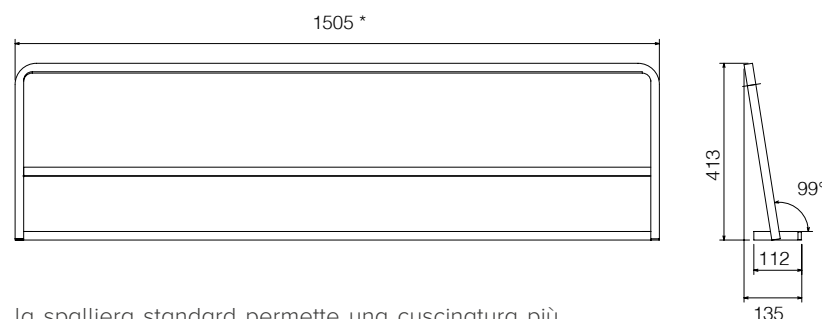

la spalliera standard permette una cuscineria più spessa e diversificata per una maggiore comodità

the standard back allowing a thicker and diversified filling for greater comfort

Portaguanciaie unico

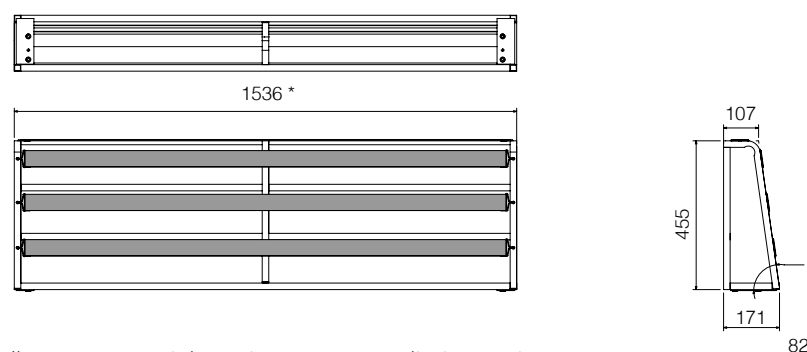

Il porta guanciaie unico permette di riporre i cuscini del letto in un unico grande vano

The single pillow holder permits to store the pillows in a single, big space

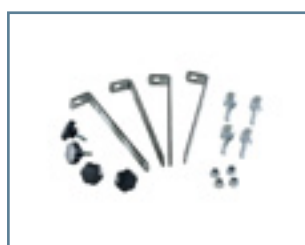

Staffa per blocco bracciolo
Art 02111/Kit/blobra
Armrest fixing bracket



Staffa attacco portaguanciaie in legno
Art 02106/kit/att/spa/leg
Fixing bracket wooden pillowstorage



Staffa per frontale divano per meccanismi a ribalta
Art. 02106 STA
Bracket for front sofa Revolving mechanism



Baionetta maschio doppia per meccanismo Penisola
Art. 02106 BAP
Double bayonet for Peninsula mechanism

Portaguanciaie doppio

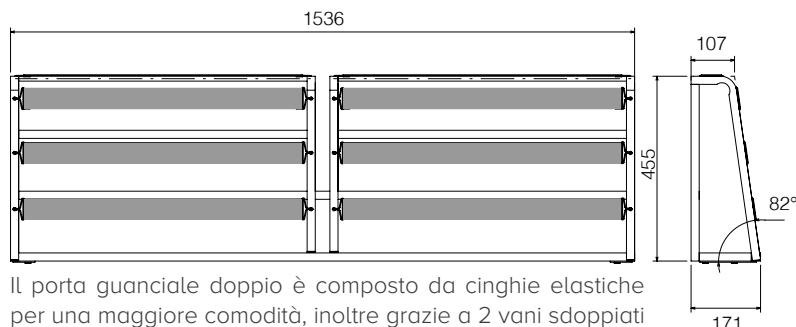
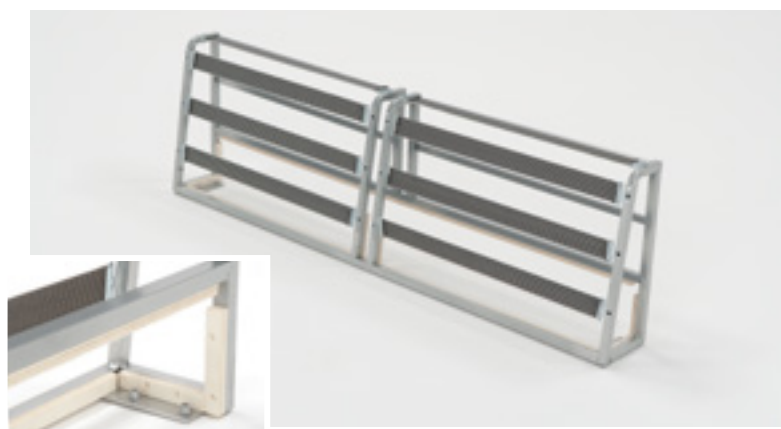

Il porta guanciaie doppio è composto da cinghie elastiche per una maggiore comodità, inoltre grazie a 2 vani sdoppiati permette di riporre i cuscini del letto.

The double pillow holder is made of elastic straps for a further comfort. Moreover, two separated spaces allow a double pillow storage.

Spalliera con poggiatesta New Roller, Fast, Height Comfort, Genius e Mec Plus+

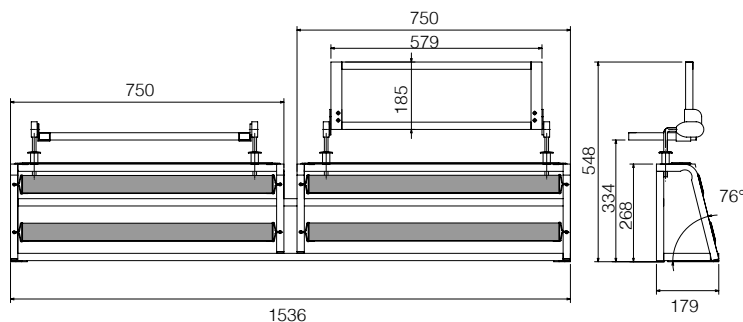

La spalliera con poggiatesta, grazie ad una cinematica a cricchetto permette la regolazione di due poggiatesta, totalmente indipendenti, una comodità per leggere o guardare la tv

Back with a ratchet headrest, allows the regulation of two headrests, that are completely independent from each other, and comfortable for reading or watching TV

Spalliera con poggiatesta Extra Smart Piede 13, Extra Smart Piede 8

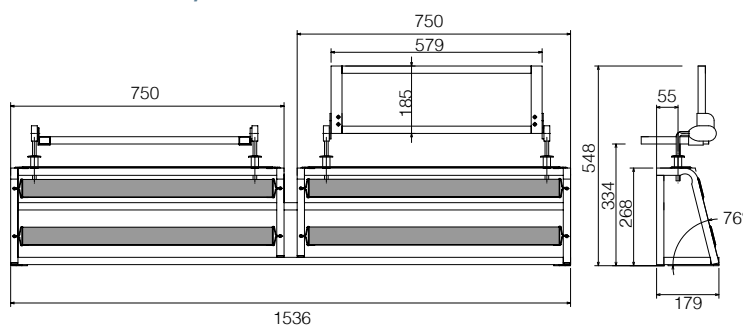

La spalliera con poggiatesta, grazie ad una cinematica a cricchetto permette la regolazione di due poggiatesta, totalmente indipendenti, una comodità per leggere o guardare la tv

Back with a ratchet headrest, allows the regulation of two headrests, that are completely independent from each other, and comfortable for reading or watching TV



Baionetta M/F
Art. 02106 BF
Art. 02106 BM



Piedi H8 / H13
Art 02100 pie
Feet H8 / H13

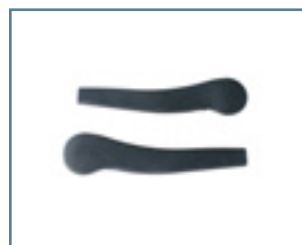

Carter ABS
Fast

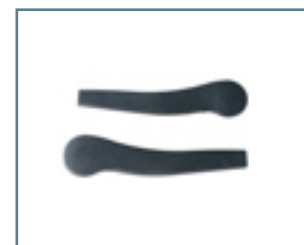

Carter ABS
Height comfort fast

Lift up Piede 8

Accessorio per meccanismi a ribalta
New Roller - Fast - Extra Smart Piede 8 - Height Comfort
Genius - Mec Plus+ M14



Innovativo sistema per tutti i meccanismi a ribalta con piede H 8. Utile per il sollevamento del divano e per un facile montaggio del bracciolo.

ART. 02106/KIT/LIFTUP

Designed to move easily the sofa bed inside the room. To simplify the assembly of the armrest.

Lift up Piede 13

Accessorio per meccanismi a ribalta
Smart Piede 13 - Extra Smart Piede 13



Innovativo sistema per tutti i meccanismi a ribalta con piede H 13. Utile per il sollevamento del divano e per un facile montaggio del bracciolo.

ART.02111/KIT/LIFTUPH13

Designed to move easily the sofa bed inside the room. To simplify the assembly of the armrest.

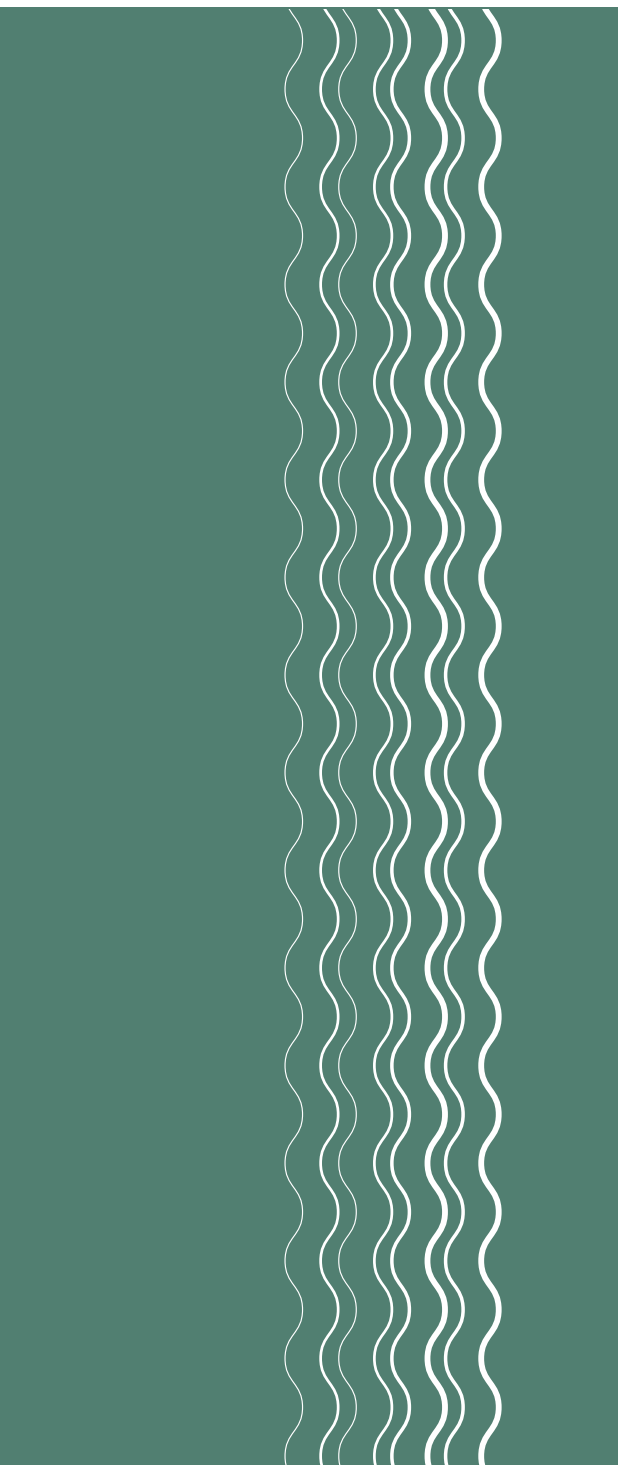
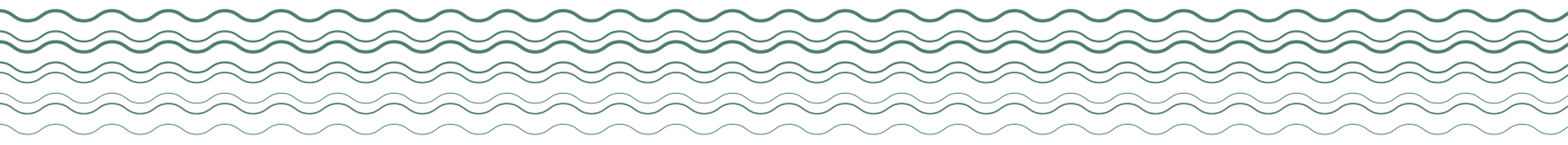

MECCANISMI DA INSERIMENTO

INSERTION
MECHANISMS



WWW.ALTALEX.IT





Slalom

Meccanismo da inserimento elettrosaldato

Meccanismo da inserimento con apertura a due pieghe, fornito di sistema ribaltamento, che consente con un unico movimento di non rimuovere i cuscini della seduta del divano.

Piano di appoggio materasso con rete in acciaio elettrosaldato e cinghie elastiche.

Telaio in tubo mobilio ad alta resistenza con verniciatura in polvere epossidica.

An insertion mechanism with two-fold opening, fitted with a tilting system that makes it possible to fold out the sofa bed in a single movement without removing the seat cushions.

Mattress support surface with base in fuse-bonded steel and elastic straps.

Ultra-strong frame in furniture tubing painted with epoxy powders.



ARTICOLO	A	B	DIMENSIONI consigliate del MATERASSO
Mec 104 Slalom 182	182	164	163x187x12
Mec 104 Slalom 162	162	144	143x187x12
Mec 104 Slalom 142	142	124	123x187x12
Mec 104 Slalom 122	122	104	103x187x12
Mec 104 Slalom 92	92	74	73x187x12
Mec 104 Slalom 82	82	64	63x187x12

1



2

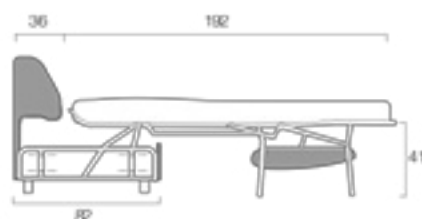

3

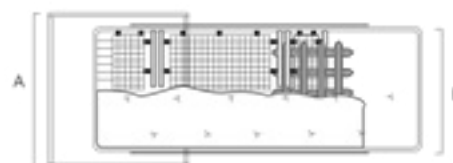
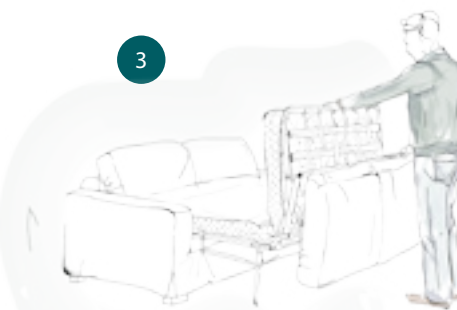

Meccanismo da inserimento elettrosaldato

Meccanismo da inserimento con apertura a due pieghe. Telaio in tubo mobile ad alta resistenza con verniciatura epossidica. Piano dormita con rete in acciaio elettrosaldato e cinghie elastiche.

An insertion mechanism with two-fold opening. Ultra-strong frame in furniture tubing painted with epoxy powders.

Sleeping surface with base in fuse-bonded steel and elastic straps, or beech wood slats or steel mesh.

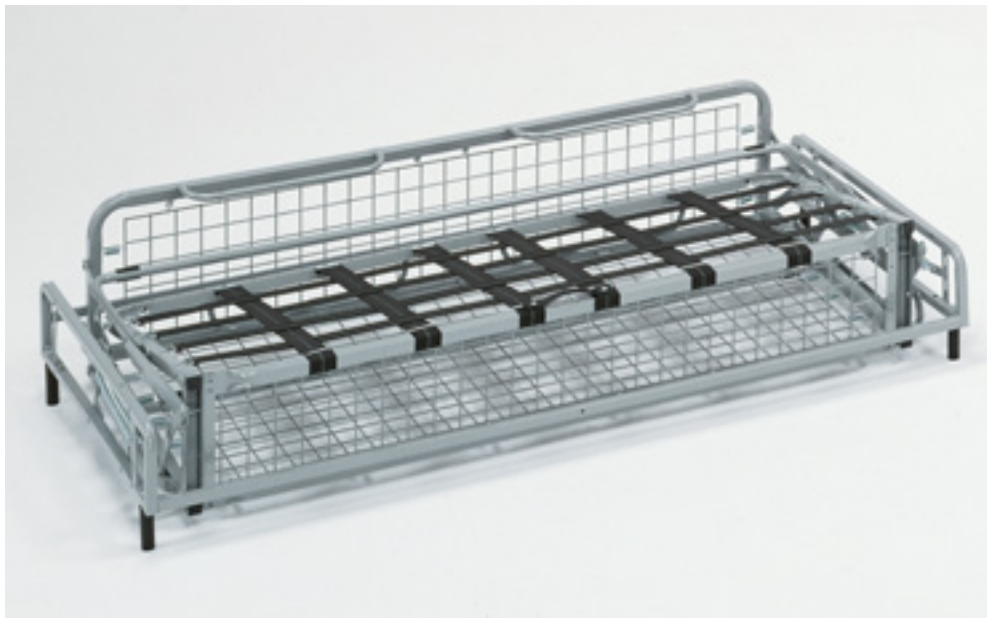

ARTICOLO	A	B	DIMENSIONE consigliata del MATERASSO
Mec 104 Large 182	182	164	163x187x12
Mec 104 Large 162	162	144	143x187x12
Mec 104 Large 142	142	124	123x187x12
Mec 104 Large 122	122	104	103x187x12
Mec 104 Large 92	92	74	73x187x12
Mec 104 Large 82	82	64	63x187x12

1



2



3

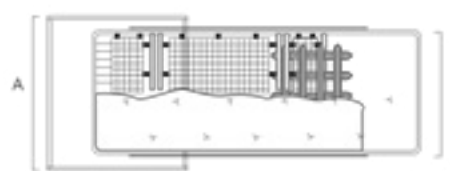
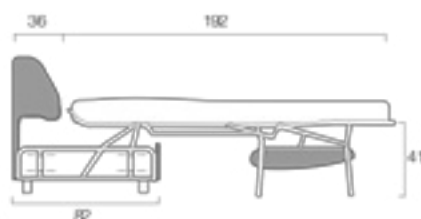

Duepieghe

Elettrocinghia

Meccanismo da inserimento con apertura a due pieghe. Telaio in tubo mobilio ad alta resistenza con verniciatura apossidica.

Piano dormita con rete in acciaio elettrosaldato e cinghie elastiche.

An insertion mechanism with two-fold opening. Ultra-strong frame in furniture tubing painted with epoxy powders.

Sleeping surface with base in fuse-bonded steel with elastic straps.



ARTICOLO	A	B	DIMENSIONI consigliate del MATERASSO
Mec 102 Due Pieghe 162	162	144	143x183x12
Mec 102 Due Pieghe 122	122	104	103x183x12
Mec 102 Due Pieghe 82	82	64	63x183x12

Disponibile anche
nella versione elettrosaldato
Also available for
fuse-bonded model

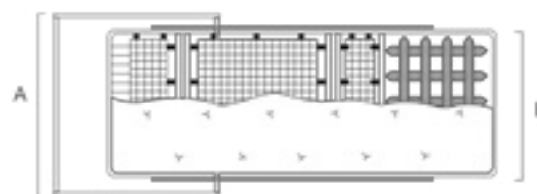
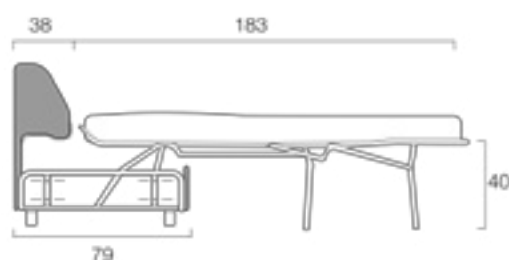
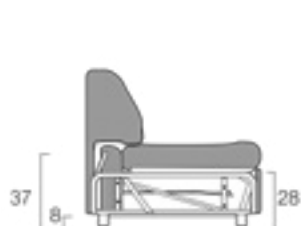

Elettrosaldata

Meccanismo da inserimento con apertura a due pieghe. Telaio in tubo mobile ad alta resistenza con verniciatura apossidica. Piano dormita con rete in acciaio elettrosaldata.

An insertion mechanism with two-fold opening. Ultra-strong frame in furniture tubing painted with epoxy powders. Sleeping surface with base in fuse-bonded.



ARTICOLO	A	B	DIMENSIONE consigliata del MATERASSO
Mec 102 due pieghe 162	162	144	143x183x12
Mec 102 due pieghe 152	152	134	133x183x12
Mec 102 due pieghe 122	122	104	103x183x12
Mec 102 due pieghe 82	82	64	63x183x12

1



2



3



Duepieghe mini

Elettrosaldata

Meccanismo da inserimento con apertura a due pieghe dal minimo ingombro.

Telaio in tubo da mobilio ad alta resistenza con verniciatura epossidica. Fornito di poggia cuscino che rende il piano dormita più lungo di 20 cm. Piano dormita con rete in acciaio elettrosaldata e cinghie elastiche.

Small-sized insertion mechanism with two-fold opening. Ultra-strong frame in furniture tubing painted with epoxy powders. Available with pillow rest that makes the sleeping surface 20 cm longer. Sleeping surface with base in fuse-bonded steel with elastic straps.

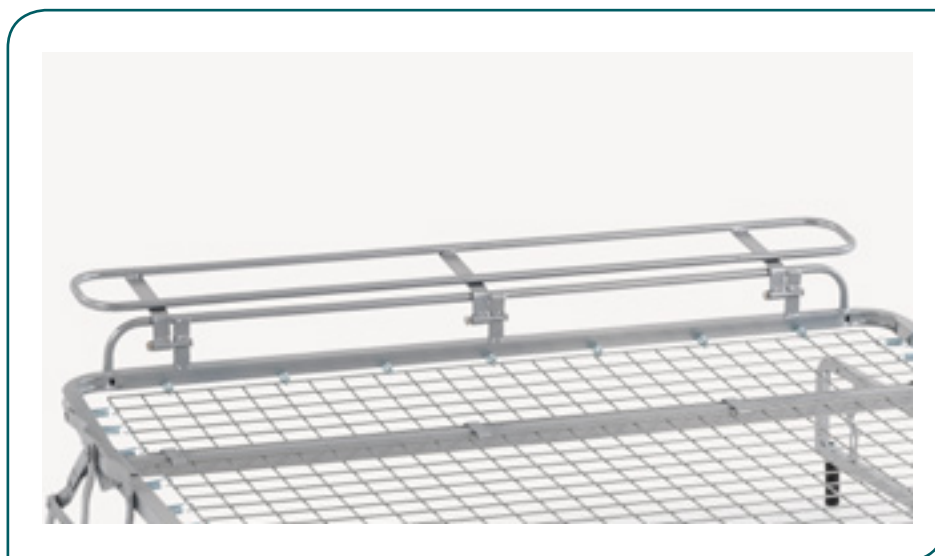

articolo	A	B	DIMENSIONI consigliate del MATERASSO
Mec 103 Due pieghe mini 162	162	144	143x173x11
Mec 103 Due pieghe mini 152	152	134	133x173x11
Mec 103 Due pieghe mini 142	142	124	123x173x11
Mec 103 Due pieghe mini 122	122	104	103x173x11
Mec 103 Due pieghe mini 112	112	94	93x173x11
Mec 103 Due pieghe mini 102	102	84	83x173x11
Mec 103 Due pieghe mini 92	92	74	73x173x11

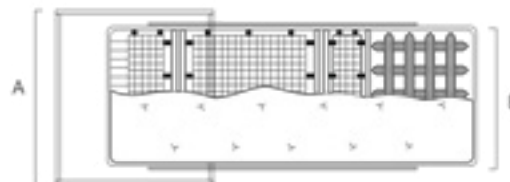
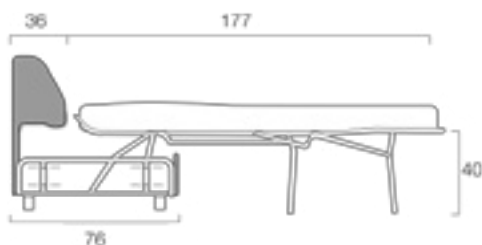
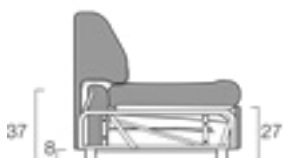



Disponibile di accessorio poggia-cuscino
che rende il piano dormita piu lungo di 20 cm
Available with pillow rest
that makes the sleeping surface 20 cm longer

1

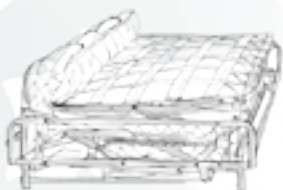

2



3



Tre pieghe

Elettrosaldata maglie

Meccanismo da inserimento con apertura a tre pieghe dal minimo ingombro.

Telaio in tubo da mobilio ad alta resistenza con verniciatura epossidica.

Piano dormita con rete in acciaio elettrosaldato o maglia.

Small-sized insertion mechanism with three-fold opening. Ultra-strong frame in furniture tubing painted with epoxy powders.

Sleeping surface with base in fuse-bonded steel, mash.



articolo	A	B	DIMENSIONI consigliate per MATERASSO
Mec 101 Tre pieghe 162	162	148	143x178x7
Mec 101 Tre pieghe 152	152	138	133x178x7
Mec 101 Tre pieghe 142	142	128	123x178x7
Mec 101 Tre pieghe 132	132	118	113x178x7
Mec 101 Tre pieghe 122	122	108	103x178x7
Mec 101 Tre pieghe 112	112	98	93x178x7
Mec 101 Tre pieghe 102	102	88	83x178x7
Mec 101 Tre pieghe 92	92	78	73x178x7

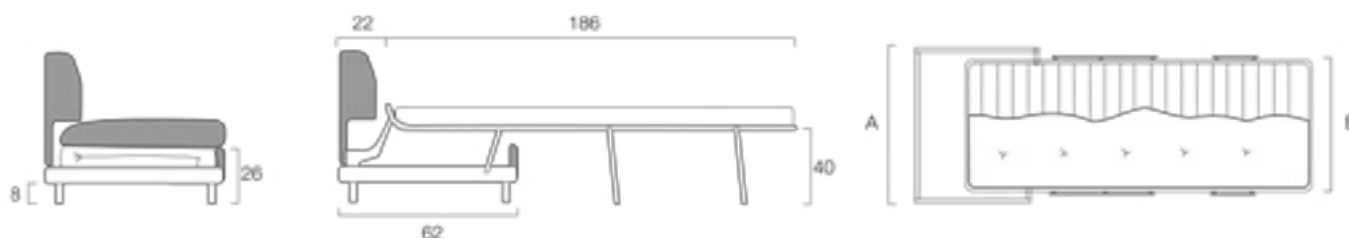



1

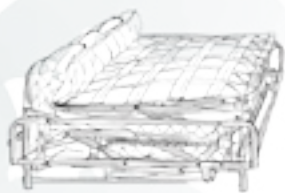

2



3



Materassi

Slalom - Large - Due pieghe - Due pieghe mini - Tre pieghe



Anallergico
Antibacterial - anti mite



Tessuto stretch
Stretch fabric



Fascia traspirante 3D
3D breathable band

Materasso Slalom Stretch

Materasso a media densità rivestito con tessuto antibatterico stretch e fascia traspirante 3D.

Mattress with medium density covered with hypoallergenic and anti-dust mite stretch fabric and 3D breathable band.

misure meccanismo (cm)	dimensione materasso (cm)	SLALOM	LARGE
182	160x185x12	✓	✓
162	140x185x12	✓	✓
142	120x185x12	✓	✓
122	100x185x12	✓	✓
92	70x185x12	✓	✓
82	60x185x12	✓	✓

Materasso Due Pieghe D21

Materasso in poliuretano di bassa densità rivestito in tessuto di poli-cotone losangato solo da un lato.

Mattress in polyurethane with low density, covered with Quilted poly-cotton fabric and with anti-dust mite treatment only for one side.



Anallergico
Antibacterial - anti mite

misure meccanismo (cm)	dimensione materasso (cm)	DUE PIEGHE	DUE PIEGHE ITALIA
162	140x179x12	✓	✓
152	130x179x12	✓	✓
122	100x179x12	✓	✓
82	60x179x12	✓	✓



Anallergico
Antibacterial - anti mite



Tessuto stretch
Stretch fabric



Fascia traspirante 3D
3D breathable band

Materasso Due Pieghe D25 Stretch

Materasso in poliuretano di media densità rivestito con tessuto stretch anallergico e fascia traspirante 3D.

Mattress with medium density covered with antibacterial - anti mite treatment and 3D breathable band.

misure meccanismo (cm)	dimensione materasso (cm)	DUE PIEGHE	DUE PIEGHE ITALIA
162	140x179x12	✓	✓
152	130x179x12	✓	✓
122	100x179x12	✓	✓
82	60x179x12	✓	✓



I Materassi sono disponibili anche nelle versioni ignifughe CLASSE 1 IM - BS 7177 - 16 CFR 1632 e 16 CFR 1633



Anallergico
Antibacterial - anti mite



Tessuto stretch
Stretch fabric



Fascia traspirante 3D
3D breathable band

Materasso Due Pieghe Mini D25 Stretch

Materasso in poliuretano di media densità rivestito con tessuto antibatterico stretch e fascia traspirante 3D.

Mattress with medium density covered with hypoallergenic and anti-dust mite stretch fabric and 3D breathable band.

misure meccanismo (cm)	dimensione materasso (cm)	DUE PIEGHE MINI
162	140x174x11	✓
152	130x174x11	✓
142	120x174x11	✓
122	100x174x11	✓
112	90x174x11	✓
102	80x174x11	✓
92	70x174x11	✓

Materasso Tre Pieghe D21 cotone

Materasso in poliuretano di bassa densità rivestito in tessuto poli-cotone losangato da ambo i lati.

Mattress in polyurethane with low density, covered with Quilted poly-cotton fabric and with anti-dust mite treatment.

misure meccanismo (cm)	dimensione materasso (cm)	TRE PIEGHE
162	140x179x7	✓
152	130x179x7	✓
142	120x179x7	✓
132	120x179x7	✓
122	100x179x7	✓
112	90x179x7	✓
102	80x179x7	✓
92	70x179x7	✓



Anallergico
Antibacterial - anti mite



I Materassi sono disponibili anche nelle versioni ignifughe CLASSE 1 IM - BS 7177 - 16 CFR 1632 e 16 CFR 1633

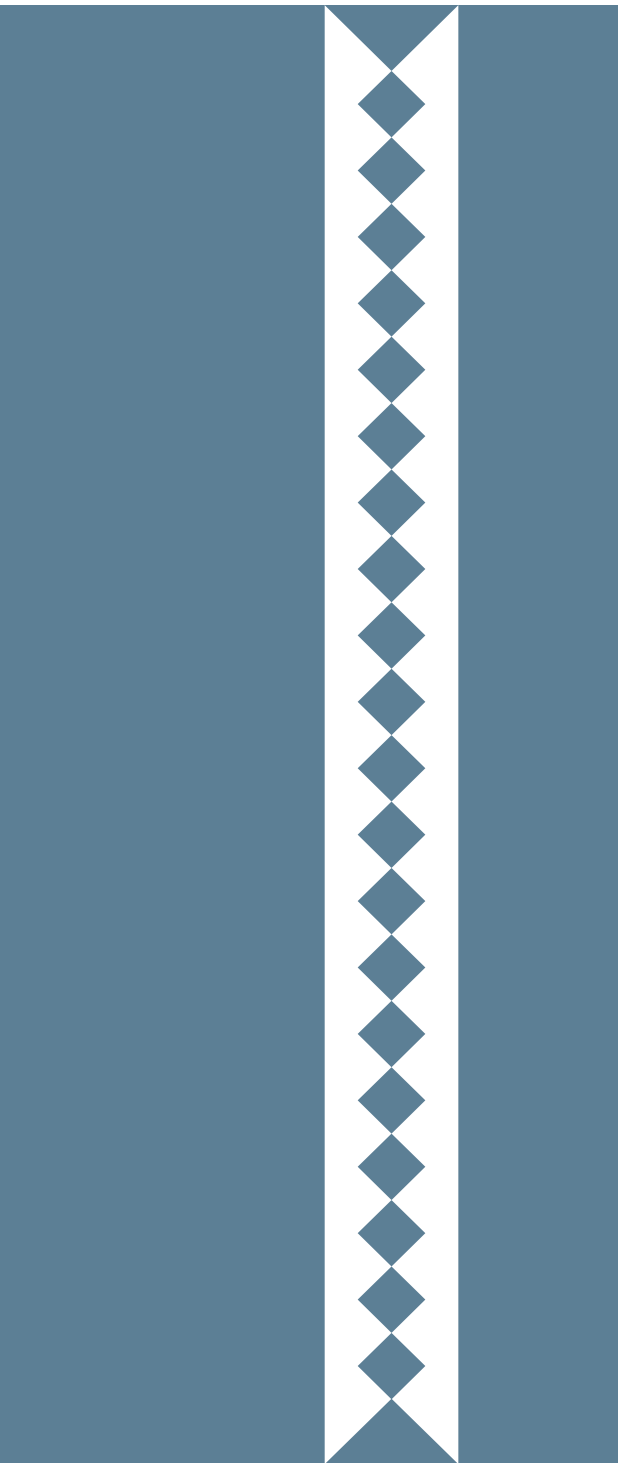

MECCANISMI
TRASFORMABILI
TRASFORMABLE
MECHANISMS



WWW.ALTALEX.IT



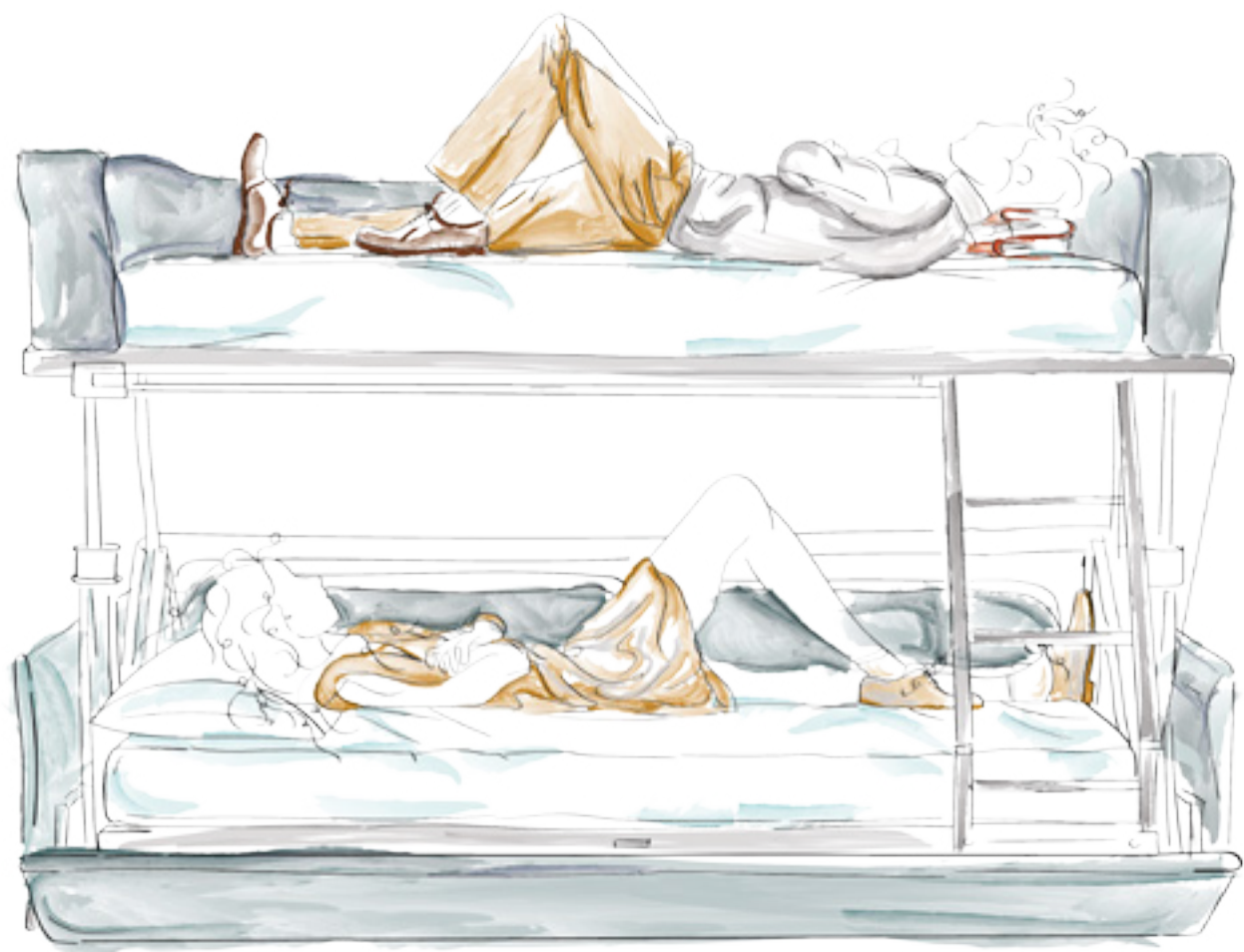

Roma

Divano letto trasformabile

Meccanismo per divano letto trasformabile che permette di ottenere due comodi letti sovrapposti. Grazie ad un unico e facile movimento si ottiene: l'apertura del meccanismo in verticale, l'avanzamento del letto inferiore e il posizionamento in automatico della scaletta. Con un successivo movimento si inserisce una spondina per il letto superiore la quale è bloccata da un dispositivo di sicurezza che blocca anche il meccanismo. Inoltre un doppio dispositivo di sicurezza posizionato sui due montanti non consente la chiusura accidentale del meccanismo. Il modello Roma è stato studiato, progettato e realizzato per soddisfare tutte quelle esigenze dove è necessario sfruttare i piccoli spazi. Infatti anche gli accessori come cuscini e schienali possono trovare spazio all'interno del divano. Il meccanismo è fornito di innesti a baionetta che facilitano il montaggio e lo smontaggio di braccioli e schienale. Il telaio è realizzato con tubo da mobilio ad alta resistenza con verniciatura epossidica. Il piano dormita è costituito da rete in acciaio elettrosaldata.

This sofa bed mechanism transforms into two comfortable overlapping beds. The easy and unique transformation system permits the lifting up of the first bed, pulling out of the second lower bed and the automatic placement of the ladder. The sideboard of the upper bed can be inserted easily and it is locked by a safety device that blocks the mechanism too. The mechanism has a double safety device, which is placed at the mechanism frame, in order to avoid any accidental closing. Our model ROMA has been studied, designed and manufactured to satisfy who lives in small apartments. In fact, all accessories can be stored inside the sofa bed. The mechanism is equipped with bayonet fixing for an easy mounting of the back and armrest. The frame is a high resistant steel structure and painted with metallic grey epoxy powder. The sleeping surface is made of an electrowelded mesh.



ARTICOLO	A	B	DIMENSIONI consigliate del MATERASSO
Roma	96	215	190x78x14

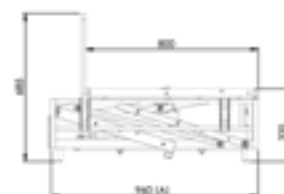



Prodotto che è stato oggetto di verifica sotto la direttiva della sicurezza generale dei prodotti (DSGP) ed anche ai sensi del Decreto n° 95-949" sulla prevenzione dei rischi derivanti dalla uso di letti a castello "di Technological Institute FCBA tramite il test rapporto n° 17-0028-0078 ME.

The product has been tested according to the General Product Safety Directive (GPSD) and according to the French Decree n. 95-949 regarding "the Risk Prevention of bunk-beds accidents", carried out by the Technological Institute FCBA as the Attestation of Conformity n. 170028-0078 ME.



Roma

Divano letto trasformabile





Doppio sistema di sicurezza
anti chiusura
Double block system
for safety lock



Anallergico
Antibacterial - anti mite



Tessuto stretch
Stretch fabric

Materasso roma

Materasso in poliuretano di media densità rivestito con tessuto stretch antiacaro.

Mattress with medium density covered with anti-dust mite stretch cover.

MISURA MATERASSO

78x190x14 cm



I Materassi sono disponibili anche nelle versioni ignifughe CLASSE 1 IM - BS 7177 - 16 CFR 1632 e 16 CFR 1633

Duplex superiore

Doghe

Meccanismo divano a tre posti, trasformabile in due letti singoli.

La parte superiore, mediante un semplice movimento scorrevole in avanti, facilita l'apertura di un posto a dormire. La parte inferiore è dotata di un sistema di scorrimento e di uno di sollevamento del posto a dormire tramite un maniglione.

Telaio in tubo da mobilio ad alta resistenza con verniciatura epossidica.

Piano dormita con doghe in faggio.

A mechanism for three-seater sofas that can convert to two single beds.

With a simple movement, the top part slides out forwards to facilitate the opening of a single bed; the bottom part has a system to slide and lift out the second bed, using a handle.

Ultra-strong frame in furniture tubing painted with epoxy powders.

Sleeping surface with beech wood slats.

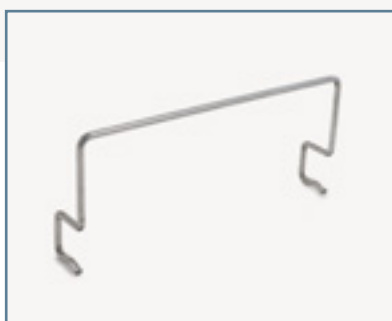
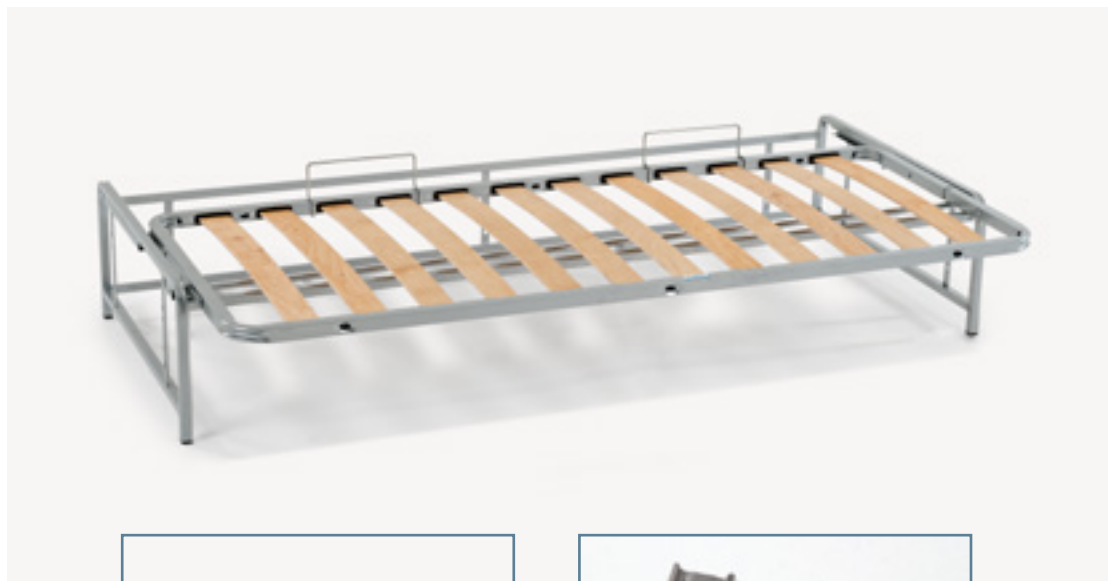
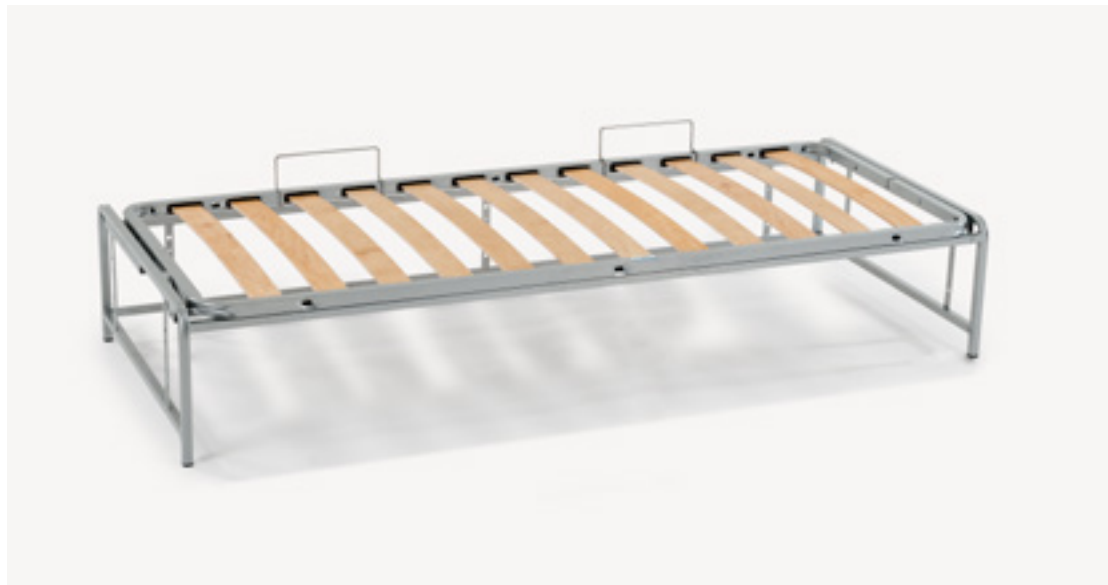

Accessorio ferma materasso
Fixing mattress



Baionetta M/F

articolo	A	B	C	D	DIMENSIONI consigliate del MATERASSO
Mec 108 Duplex Sup D 73	73	183	78,5	190	73x183x14
Mec 108 Duplex Sup D 80	80	190	85,5	197	80x190x14

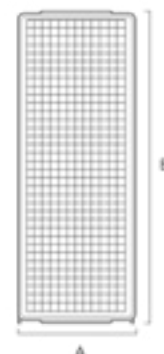

Duplex inferiore

Doghe



ARTICOLO	A	B	DIMENSIONI consigliate del MATERASSO
Mec 108 Duplex Inf D 73	73	183	73x183x14
Mec 108 Duplex Inf D 80	80	190	80x190x14

Duplex inferiore lampo

Doghe

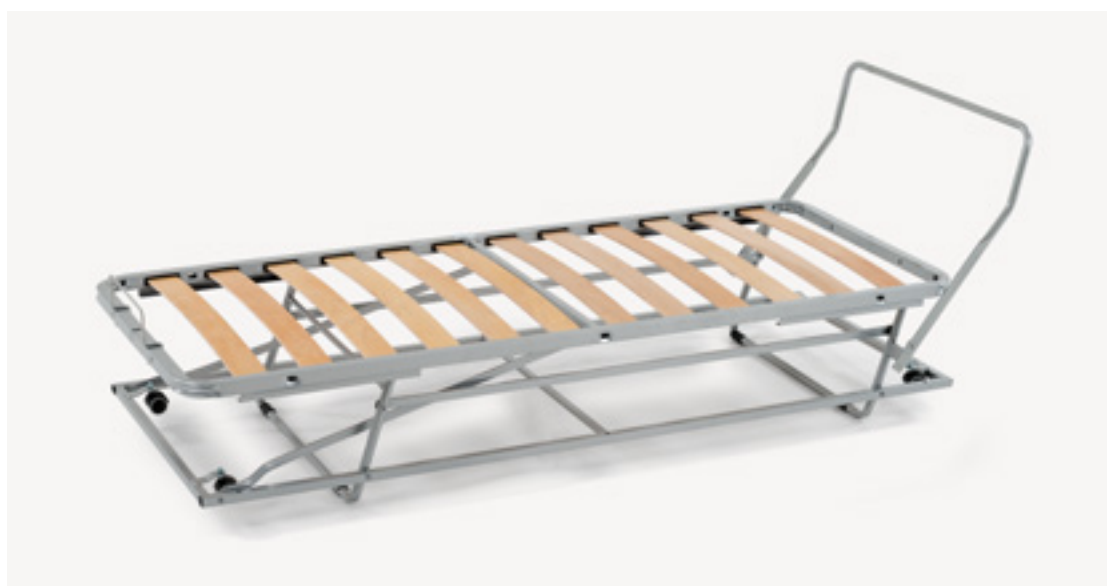

ARTICOLO	A	B	DIMENSIONI consigliate del MATERASSO
Mec 108 Duplex Inf D 73	73	183	73x183x14
Mec 108 Duplex Inf D 80	80	190	80x190x14

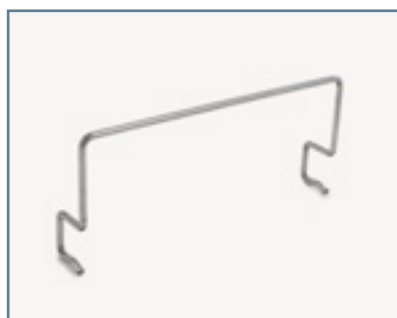

Accessorio Ferma materasso
Fixing mattress.



Staffe attacco tavoletta
Fixing bracket for Duplex frontal .

Duplex superiore

Elettrosaldata

Meccanismo divano a tre posti, trasformabile in due letti singoli.

La parte superiore, mediante un semplice movimento scorrevole in avanti, facilita l'apertura di un posto a dormire. La parte inferiore è dotata di un sistema di scorrimento e di uno di sollevamento del posto a dormire tramite un maniglione.

Telaio in tubo da mobilio ad alta resistenza con verniciatura epossidica.

Piano dormita con rete elettrosaldata.

A mechanism for three-seater sofas that can convert to two single beds.

With a simple movement, the top part slides out forwards to facilitate the opening of a single bed; the bottom part has a system to slide and lift out the second bed, using a handle.

Ultra-strong frame in furniture tubing painted with epoxy powders.

Sleeping surface with fuse bonded.

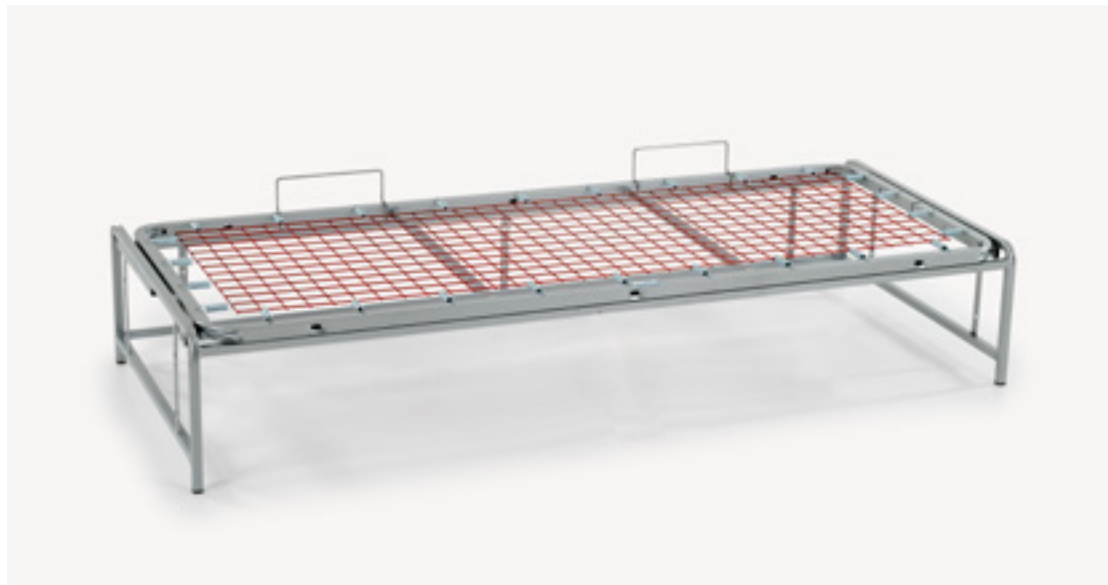

ARTICOLO	A	B	C	D	DIMENSIONI consigliate del MATERASSO
Mec 108 Duplex Sup El 73	73	183	78,5	190	73x183x14
Mec 108 Duplex Sup El 80	80	190	85,5	197	80x190x14

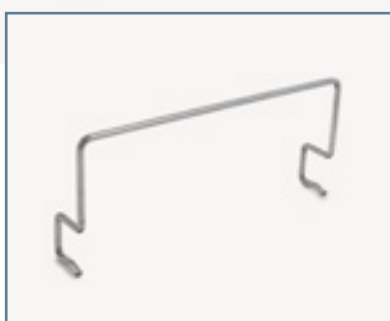

Accessorio ferma materasso
Fixing mattress



Baionetta M/F

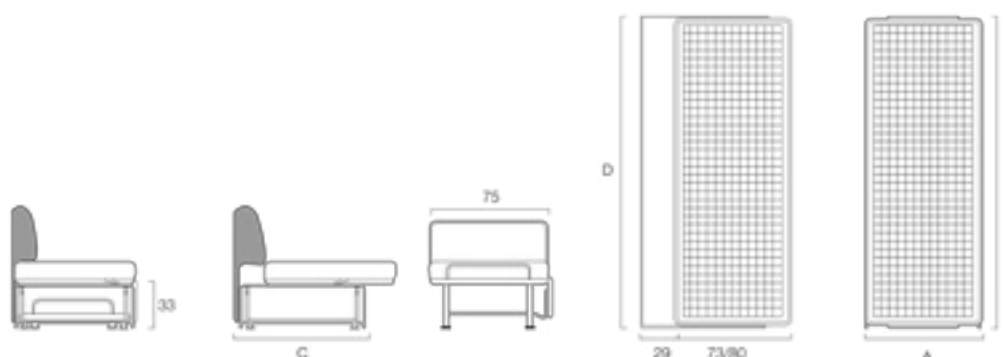

Duplex inferiore

Elettrosaldata

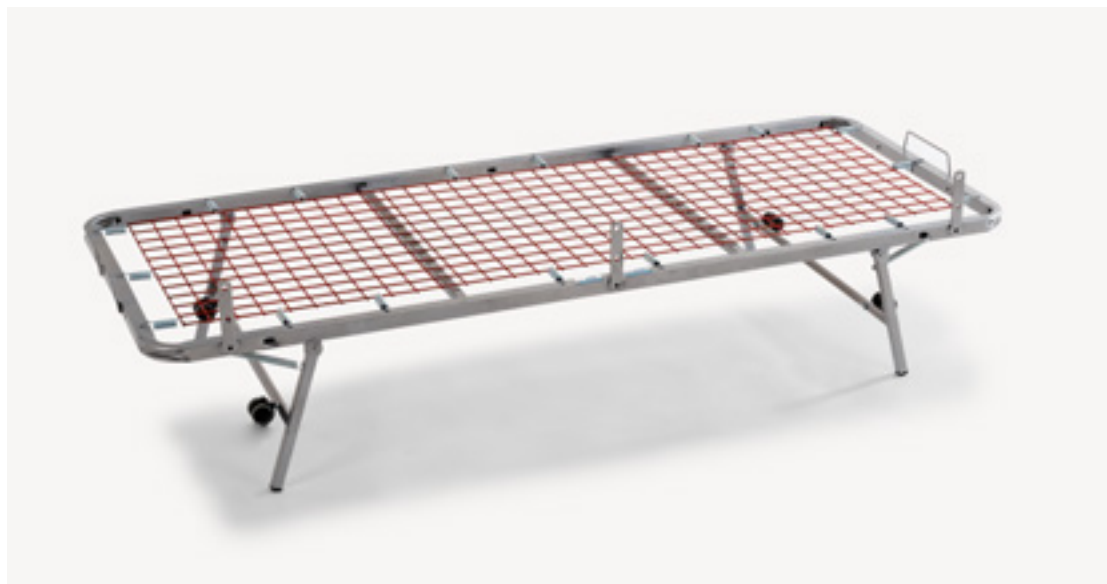

ARTICOLO	A	B	DIMENSIONI consigliate del MATERASSO
Mec 108 Duplex Inf EI 73	73	183	73x183x14

Duplex inferiore lampo

Elettrosaldata



ARTICOLO	A	B	DIMENSIONI consigliate del MATERASSO
Mec 108 Duplex InfL EI 73	73	183	73x183x14
Mec 108 Duplex InfL EI 80	80	190	80x190x14

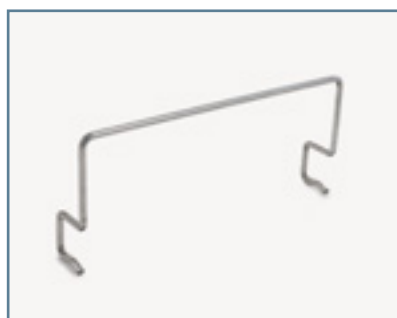

Accessorio Ferma materasso
Fixing mattress.



Staffe attacco tavoletta
Fixing bracket for Duplex frontal .

Space

Elettrosaldata apertura laterale

Grazie ad una cinematica dotata di pistoni a gas, il modello SPACE oltre ad offrire un letto singolo, con un semplice movimento manuale del piano dormita, è possibile sfruttare la parte sottostante come contenitore porta biancheria.

Thanks to a kinematics with gas pistons, model Space offers a single bed, with a simple manual movement of the sleep plan, and a linen container into the below part.



articolo	A	B	DIMENSIONI consigliate del MATERASSO
Mec Space El 80 FRONT.	80	192	80x190x14
Mec Space El 90 FRONT.	90	202	90X200X14
Mec Space El 80 LAT.	80	192	80x190x14
Mec Space El 90 LAT.	90	202	90X200X14

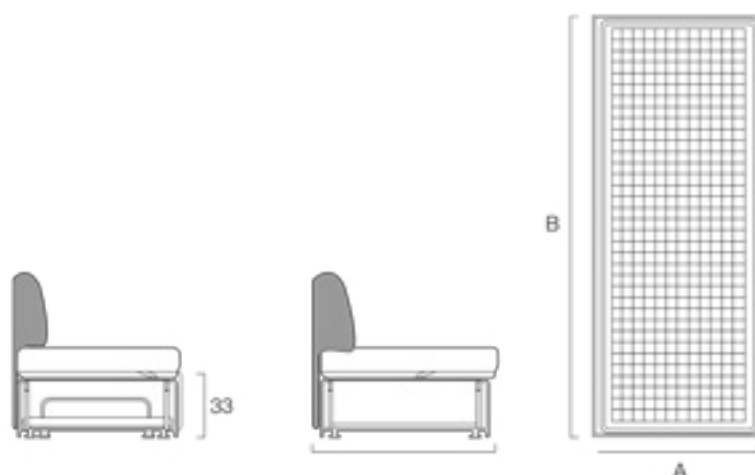

Space

Elettrosaldata apertura frontale

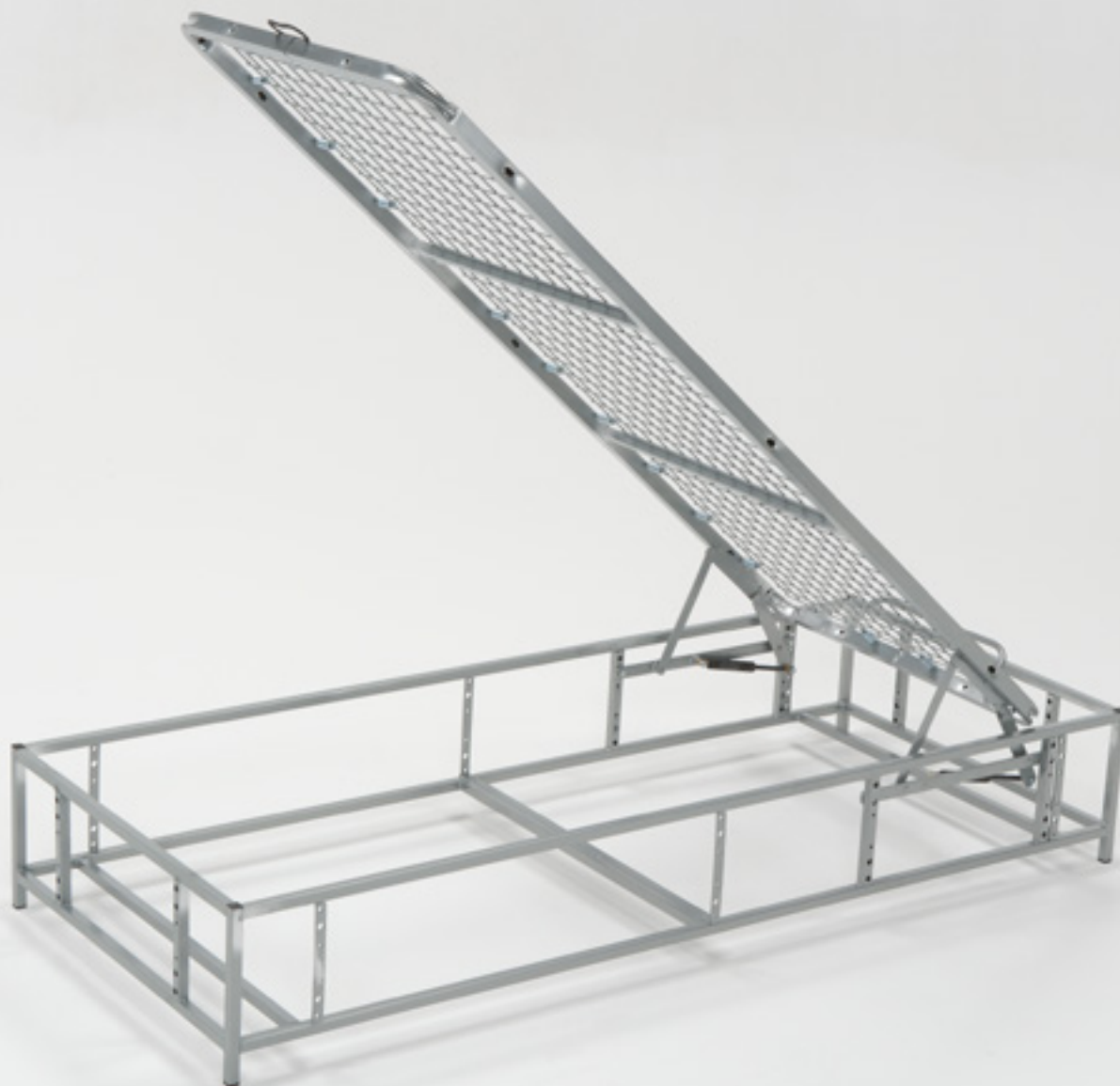

Baionetta M/F

Space double

Elettrosaldato

Il modello Space Double può essere un divano tre posti o un letto singolo. È fornibile anche con un meccanismo supplementare automatico da usare come letto singolo o per formare un matrimoniale con la parte soprastante. Telaio in tubo mobilio ad alta resistenza con verniciatura epossidica.

Piano dormita con rete elettrosaldato in acciaio.

The model Double Space can be a 3seater sofa or a single bed. It's also available with an additional automatic mechanism to be used as single bed or to create a double bed with the above part. High strength tube frame epoxy paint. Sleep plan made with an electrowelded steel deck.

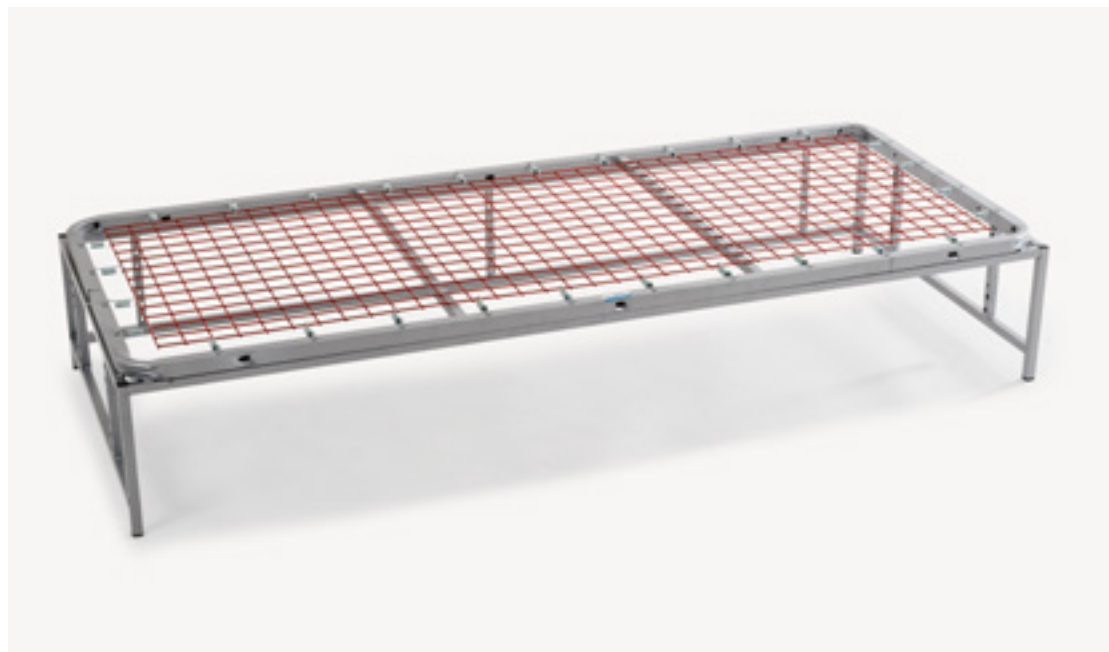

articolo	A	B	DIMENSIONI consigliate del MATERASSO
Mec 118 Space Double EI 80	80	190	80x190x14
Mec 108 Duplex Inf EI 73	73	183	73x183x14
Mec 118 Space Double EI 90	90	200	90x200x14
Mec 108 Duplex Inf EI 80	80	190	80x190x14

Meccanismi che si possono inserire nella parte inferiore
Mechanisms that can be put in the lower part



Duplex inferiore elettrosaldato



Duplex inferiore lampo elettrosaldato

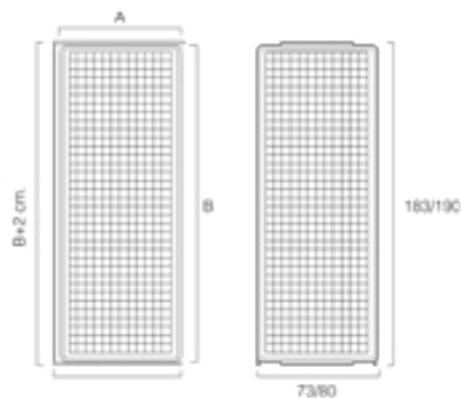

Baionetta M/F

Elettrosaldata

Meccanismo divano a due posti trasformabile in letto singolo mediante sistema di apertura laterale a tre posizioni di inclinazione dei braccioli. Telaio in tubo da mobilio ad alta resistenza con verniciatura epossidica. Piano dormita con rete elettrosaldata.

A mechanism for two-seater sofas that converts to a single bed with a side opening system and three different armrest angles.

Ultra-strong frame in furniture tubing painted with epoxy powders.

Sleeping surface with fuse-bonded base.



articolo	A	B	DIMENSIONI consigliate del MATERASSO
Mec 116 Ciak 1 piede fron.	80	202	80x198x13



Anallergico
Antibacterial - anti mite



Tessuto stretch
Stretch fabric

Materasso ciak

Materasso in poliuretano di media densità rivestito con tessuto stretch antiacaro.

Mattress with medium density covered with anti-dust mite stretch cover.

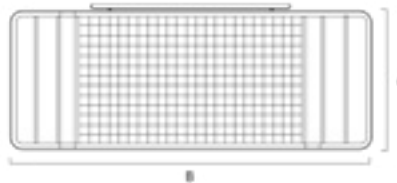
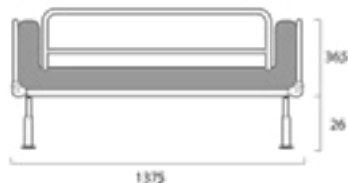
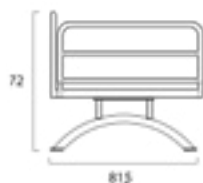

I Materassi sono disponibili anche nelle versioni ignifughe CLASSE 1 IM - BS 7177 - 16 CFR 1632 e 16 CFR 1633

Materassi

Duplex, space



Anallergico
Antibacterial - anti mite

Materasso Duplex D 21 cotone

Materasso in poliuretano di bassa densità rivestito in tessuto di poly-cotone losangato solo da ambo i lati.

Mattress in polyurethane low density, covered with quilted poly-cotton fabric and treated with anti-mite.

	misura meccanismo PIANO DORMITA (cm)	DUPLEX		SPACE/SPACE DOUBLE	
		80	73	90	80
dimensione materasso (cm)	90x200	✗	✗	✓	✗
	80x190	✓	✗	✗	✓
	73x183	✗	✓	✗	✗

Materasso Duplex D25 Stretch

Materasso in poliuretano di media densità rivestito con tessuto antibatterico stretch e fascia traspirante 3D.

Mattress in polyurethane with medium density, covered with hypoallergenic and anti-dust mite stretch fabric and 3D breathable band.



Anallergico
Antibacterial - anti mite



Tessuto stretch
Stretch fabric



Fascia traspirante 3D
3D breathable band

	misura meccanismo PIANO DORMITA (cm)	DUPLEX SUPERIORE / INFERIORE		SPACE/ SPACE DOUBLE	
		80	73	90	80
dimensione materasso (cm)	90x200	✗	✗	✓	✗
	80x190	✓	✗	✗	✓
	73x183	✗	✓	✗	✗



I Materassi sono disponibili anche nelle versioni ignifughe CLASSE 1 IM - BS 7177 - 16 CFR 1632 e 16 CFR 1633



Anallergico
Antibacterial - anti mite



Materiale a memoria
Confort memory



Tessuto stretch
Stretch fabric



Fascia traspirante 3D
3D breathable band

Materasso Duplex D30 Memory

Il Materasso Duplex D30 Memory, grazie alla sua struttura combinata in Memory Foam e Poliuretano ad alta densità, garantisce una maggiore ergonomicità donando un comfort incomparabile. È consigliato per chi necessita di un letto più accogliente e ben sostenuto. Rivestito con tessuto stretch e design innovativo e moderno.

Mattress Duplex D30 Memory is considered a real bed mattress. The combination of Memory Foam and Polyurethane ensures the maximum expression of ergonomic and comfort. It is perfect for a domestic daily use of the sofa bed, guaranteeing the well-being of a real bed mattress. Covered with a stylish and hypoallergenic stretch fabric.

	misura meccanismo PIANO DORMITA (cm)	DUPLEX SUPERIORE / INFERIORE		SPACE/ SPACE DOUBLE	
		80	73	90	80
dimensione materasso (cm)	90x200	x	x	✓	x
	80x190	✓	x	x	✓
	73x183	x	✓	x	x

Accessori

Duplex, space

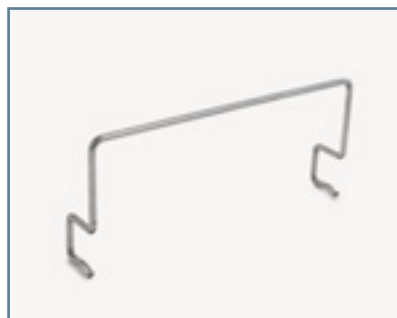

Accessorio Ferma materasso
ART. 02108
Fixing mattress.



Staffe attacco tavoletta
ART. 02108
Fixing bracket for Duplex frontal .



Baionetta M/F
ART. 02106 BF
ART. 02106 BM

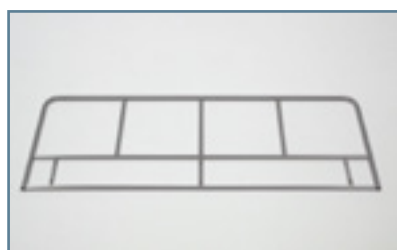

Spalliera per Mec.
Duplex/Duplex Lampo
Mis. 73 - Art. 02108 spa-dupl



Bracciolo per Mec.
Duplex/Duplex Lampo
Art. 02108 bra-dupl



I Materassi sono disponibili anche nelle versioni ignifughe CLASSE 1 IM - BS 7177 - 16 CFR 1632 e 16 CFR 1633

Evening

Elettrosaldata, doga

Meccanismo trasformabile in letto mediante la semplice apertura a scorrimento anteriore. Dotato sulla base di attacchi per l'inserimento di braccioli e spalliera.

Telaio in tubo da mobilio ad alta resistenza con verniciatura epossidica.

Piano dormita con doghe in legno o rete in acciaio elettrosaldato.

Può essere fornito anche di materasso in poliuretano in varie altezze rivestito in cotone o tnt.

A mechanism that converts to a bed by simply opening and sliding it out to the front. The base is fitted with attachments for the insertion of armrests and back.

Ultra-strong frame in furniture tubing painted with epoxy powders.

Sleeping surface with wooden slats or base in fuse-bonded steel.

Also available with polyurethane mattress of various heights, covered with cotton or tnt.



articolo	A	B	DIMENSIONI consigliate del MATERASSO
Mec 107 Evening E1 160	160	190	160x190x9/12
Mec 107 Evening E1 120	120	190	120x190x9/12
Mec 107 Evening E1 80	80	190	80x190x9/12
Mec 107 Evening D 160	160	190	160x190x9/12
Mec 107 Evening D 120	120	190	120x190x9/12
Mec 107 Evening D 80	80	190	80x190x9/12

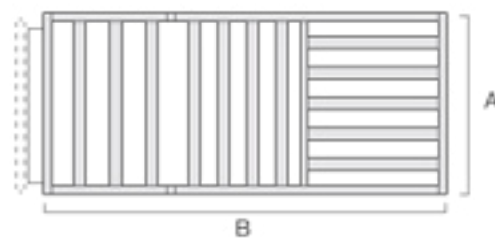
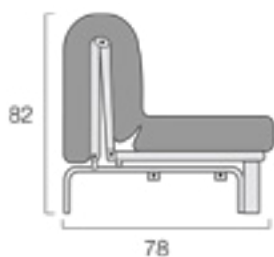

Evening



Spalliera arco per Mec. Evening
Mis. 160/120/80 - Art. 02107 spa-arc



Bracciolo per Mec. Evening
Mis. 160/120/80 - Art. 02107 bra-tub



Gancio materasso per rete elettr.
Art. 507/GAN



Staffe per Mec. Evening
Art. 02107 spa-u



Anallergico
Antibacterial - anti mite

Materasso Evening

Materasso in poliuretano di media densità rivestito in tessuto policotone losangato solo da un lato.

Mattress in polyurethane with low density, covered (one side) with poly-cotton fabric and with anti-dust mite treatment.

Disponibile anche nella versione TNT
Also available with TNT cover.

Pouff

Meccanismo Pouff, trasformabile in letto singolo, mediante sistema di frontale con un semplice ed unico movimento.

Telaio in tubo da mobilio ad alta resistenza con verniciatura epossidica.

Piano dormita in rete elettrosaldata.

Può essere fornito anche di materasso in poliuretano in cotone losangato ed imballo in cartone.

Pouff mechanism that converts to a single bed with a frontal system that requires a simple, single movement.

Ultra-strong frame in furniture tubing painted with epoxy powders.

Sleeping surface with fuse-bonded base.

Available with polyurethane mattress with lozenge-pattern cotton and cardboard packaging.



articolo	A	B	DIMENSIONI consigliate del MATERASSO
Mec 115 Pouf EI	70	190	70x190x12

Il meccanismo viene fornito di imballo in cartone e materasso

Mechanism is provided packaging and mattress

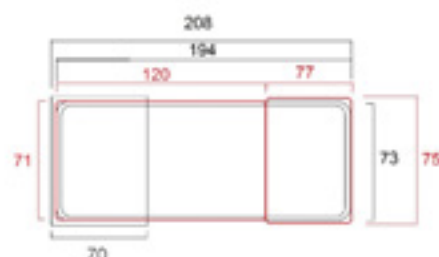
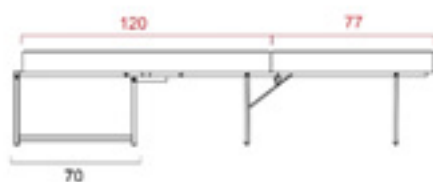
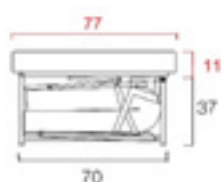

N.B. - IN ROSSO LE MISURE DEL MATERASSO

Pouff con centina



articolo	A	B	DIMENSIONI consigliate del MATERASSO
Mec 115 Pouf EI	70	190	70x190x12

● Accessorio che trasforma il meccanismo pouff in una comoda poltrona letto, dalle contenute dimensioni che si adatta a tutti gli ambienti
Accessory that turns the mechanism pouff in a comfortable sofa bed

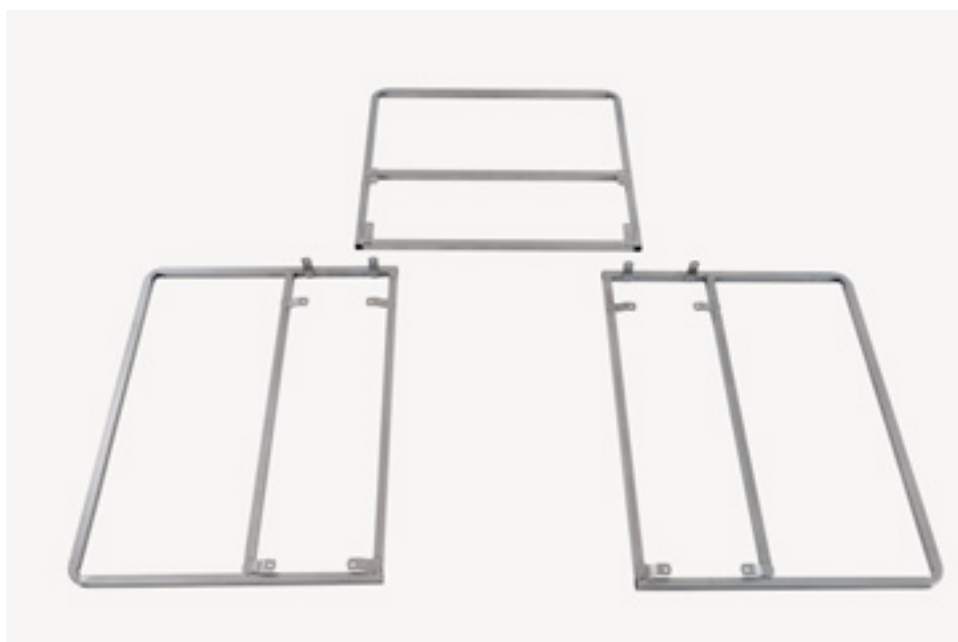

Anallergico
Antibacterial - anti mite



Tessuto stretch
Stretch fabric

Materasso Pouff stretch

Materasso in poliuretano di media densità rivestito con tessuto stretch anti-acaro.

Mattress in polyurethane with medium density, covered with stretch fabric and with anti-dust mite treatment.

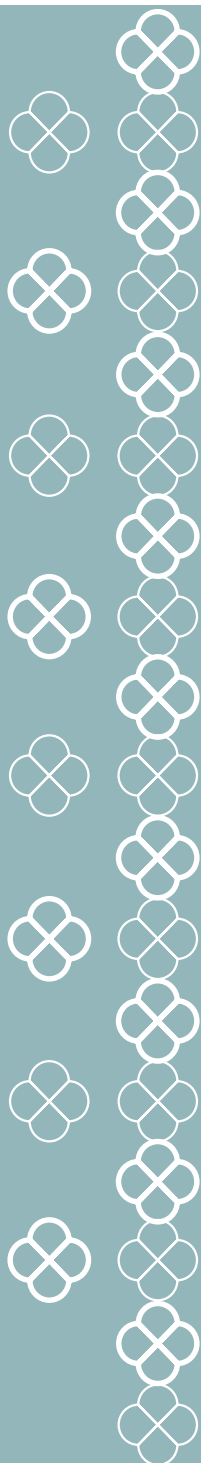
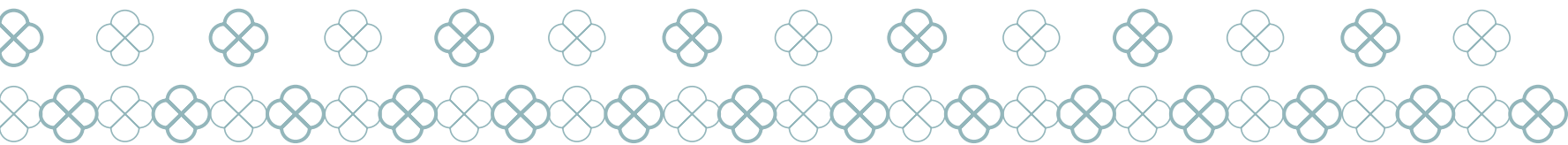

MECCANISMI PER LETTO

BED
MECHANISMS



WWW.ALTALEX.IT





Raffaello

Meccanismo due movimenti con telaio
 disponibile anche in versione singola con apertura laterale

Il modello Raffaello grazie alla cinematica brevettata e all'utilizzo di pistoni a gas, con un semplice gesto, permette il sollevamento del letto, per un facile e comodo riassetto.

Nella posizione intermedia invece, il letto si posiziona in modo tale da avere libero accesso al contenitore sottostante, oppure al pavimento, consentendo così una facile e rapida pulizia. Grazie al doppio telaio, il modello Raffaello si colloca perfettamente nei letti già esistenti perché non necessita di attacchi. Inoltre il modello Raffaello con l'applicazione dei piedi diametro 50 mm (optional) diventa autoportante. Telaio in tubolare di acciaio 50x30 mm, con piano di riposo composto di 14 listelli in multistrato di faggio da 68x8 mm ancorate con supporti nylon. Due traverse di rinforzo in tubo di acciaio 40x30 mm con protezione anticigolio, garantiscono un supporto rigido. Verniciatura a polvere epossidica.

The Raffaello bed base, thanks to its patented cinematic and to the use of gas pistons, lifts by a simple move that allows making the bed in a comfortable and easy way. At the middle-position of the bed, it is possible to have a free access to the floor, for an easy and fast cleaning, as well as to the storage, located underneath the sleeping surface.

Thanks to its double frame, the Raffaello bed base can be also perfectly placed in existing beds, because it does not need any attachment. Furthermore, the Raffaello bed base with the addition of feet, 50mm of diameter (optional pieces), becomes self-supporting. The tubular steel frame of 50x30mm has a sleeping surface made of 14 multilayer beech wooden slats, 68x8 mm each, that are fixed with nylon supports. Two tubular steel slats 40x30 mm, used to reinforce the bed, and the anticreaking pads, guarantee a strong support. It is painted with epoxy powder.

articolo	A	B
Mec 03305 Raffaello	160/165/170	190/195/200

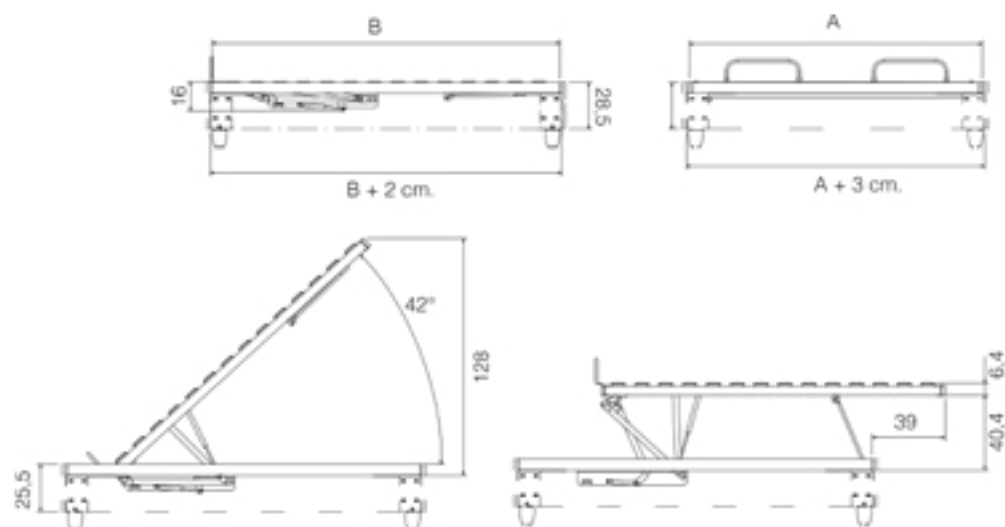



Accessori



Traversa per contenitore
ART 03300/T
lung. = A+3 cm



Kit angolare universale
ART. 02114/ANG/UNI



Kit angolare alto
ART. 02114/ANG/ALT



Baionetta M/F
ART. 02106 BF
ART. 02106 BM



Kit n° 4 piedi
in acciaio verniciati
H 25/30/35/40

System

Doppio movimento

Il modello System grazie alla cinematica brevettata e all'utilizzo di pistoni a gas, con un semplice gesto, permette il sollevamento del letto, per un facile e comodo riassetto.

Telaio in tubolare di acciaio 50x30 mm, con piano di riposo composto di 14 listelli in multistrato di faggio da 68x8 mm ancorate con supporti nylon.

Due traverse di rinforzo in tubo di acciaio 40x30 mm con protezione anticigolio, garantiscono un supporto rigido.

Verniciatura a polvere epossidica.

Nella posizione intermedia invece, il letto si posiziona in modo tale da avere libero accesso al contenitore sottostante.

The System bed base, thanks to its patented cinematic and to the use of gas pistons, lifts by a simple move that allows making the bed in a comfortable and easy way

At the middle-position of the bed, it is possible to have a free access to the floor.

The tubular steel frame of 50x30mm has a sleeping surface made of 14 multilayer beech wooden slats, 68x8 mm each, that are fixed with nylon supports.

Two tubular steel slats 40x30 mm, used to reinforce the bed, and the anticreaking pads, guarantee a strong support.



articolo	A	B
Mec 114S System	160/165/170	190/195/200

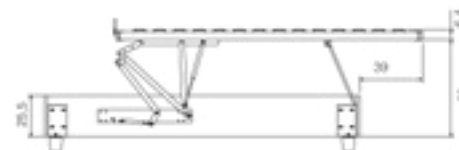
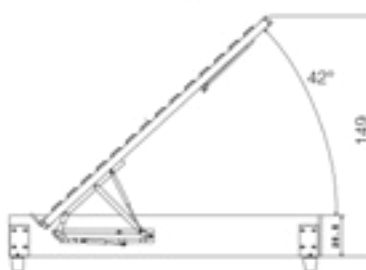
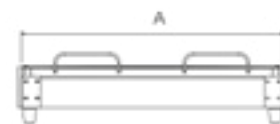
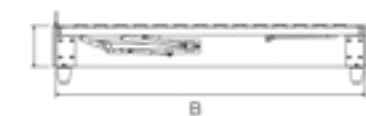



Accessori



Traversa per contenitore
ART 03300/T
lung. = A+3 cm



Kit angolare universale
ART. 02114/ANG/UNI



Kit angolare alto
ART. 02114/ANG/ALT



Baionetta M/F
ART. 02106 BF
ART. 02106 BM

Asiago

Letto contenitore, che grazie a una coppia di meccanismi di sollevamento con molle a gas, consentono l'apertura del piano dormita, rendendo disponibile un vano collocato sotto la rete utile per riporre cuscini, coperte, ecc.

Telaio in tubo da mobilio ad alta resistenza con verniciatura epossidica.

Piano dormita con doghe in faggio.

Storage bed that, thanks to a pair of lifting mechanisms with gas springs, opens up the sleeping surface to reveal a storage compartment under the bed base that can be used for pillows, blankets, etc.

Ultra-strong frame in furniture tubing painted with epoxy powders.

Sleeping surface with beech wood slats.

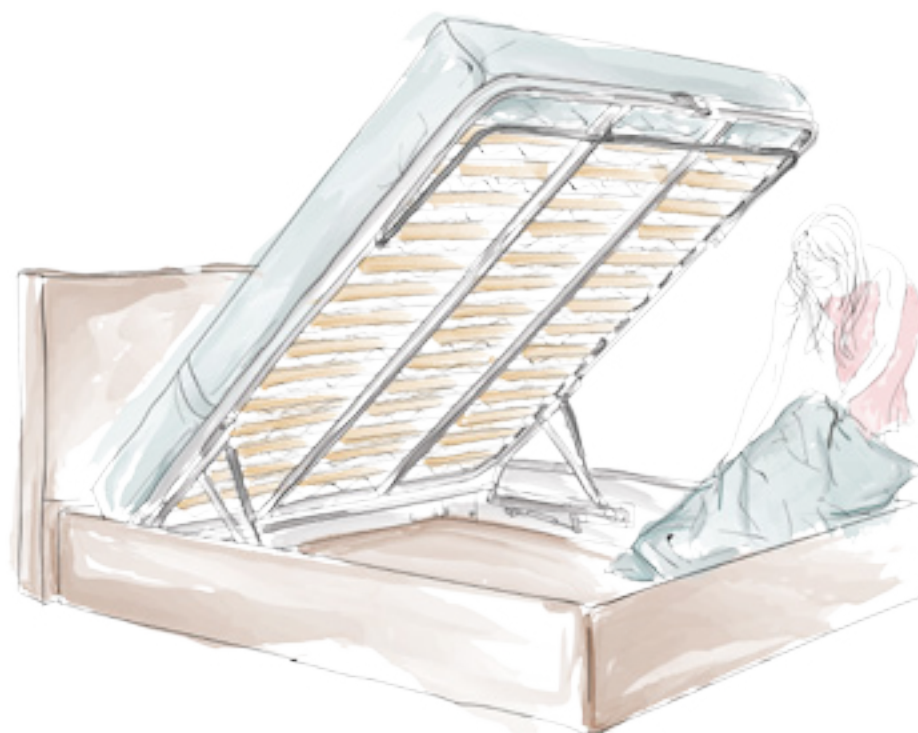

articolo	A	B
Mec 114 Asiago	160/165/170	190/195/200
Mec 114 Asiago	80/90/120	190/195/200

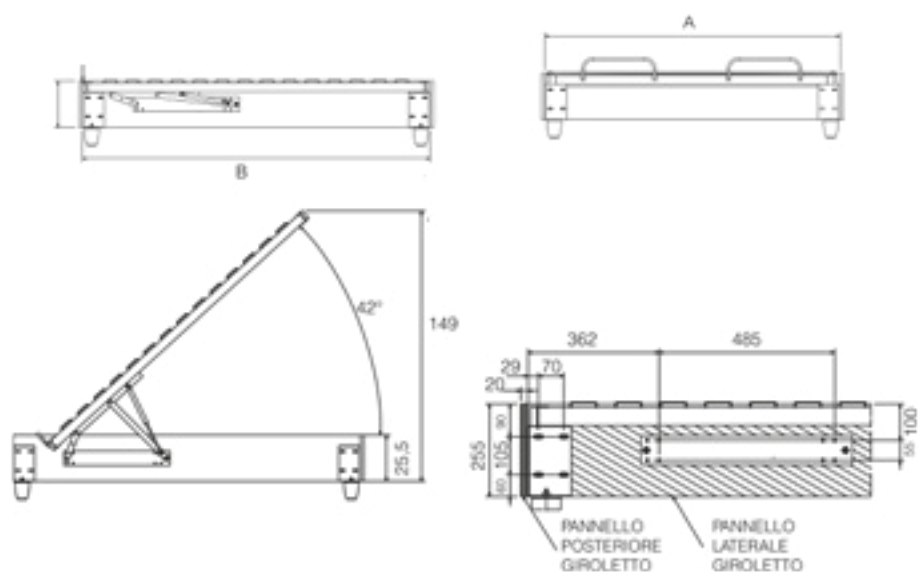



Accessori



Traversa per contenitore
ART 03300/T
lung. = A+3 cm



Kit angolare universale
ART. 02114/ANG/UNI



Kit angolare alto
ART. 02114/ANG/ALT



Baionetta M/F
ART. 02106 BF
ART. 02106 BM

Picasso

Rete Picasso matrimoniale il piano letto è costituito da unica doga in multistrato di faggio, con due traverse centrali di rinforzo con protezione anticigolio, garantiscono un supporto rigido.

Telaio in tubolare di acciaio 50x30 mm, con piano di riposo 14 listelli in multistrato di faggio da 68x8 mm, ancorate con supporti in nylon. Due traverse di rinforzo in tubo di acciaio 40x30mm con protezione anticigolio, garantiscono un supporto rigido. Verniciatura a polvere epossidica.

The Picasso double- bed base is made of a single, multilayer beech wooden slat, with two central crossbars for the reinforcement and an anticreaking protection, that guarantee a rigid support.

The Tubular steel frame 50x30mm, with a sleeping surface composed of 14 multilayer beech wooden slats 16x8mm each is fixed with nylon supports. Two crossbars for the reinforcement made in tubular steel 40x 30 mm with an anticreaking protection, guarantee a rigid support. Painted with epoxy powders.



- Giunzione angolare personalizzata e dal design raffinato
Stylish and personalized corner joint

articolo	A	B
Mec 03305 Picasso	160/165/170/180	190/195/200
Mec 03305 Picasso	80/85/90/120/140	190/195/200



Kit n° 4 piedi in acciaio verniciati
H 25/30/35/40



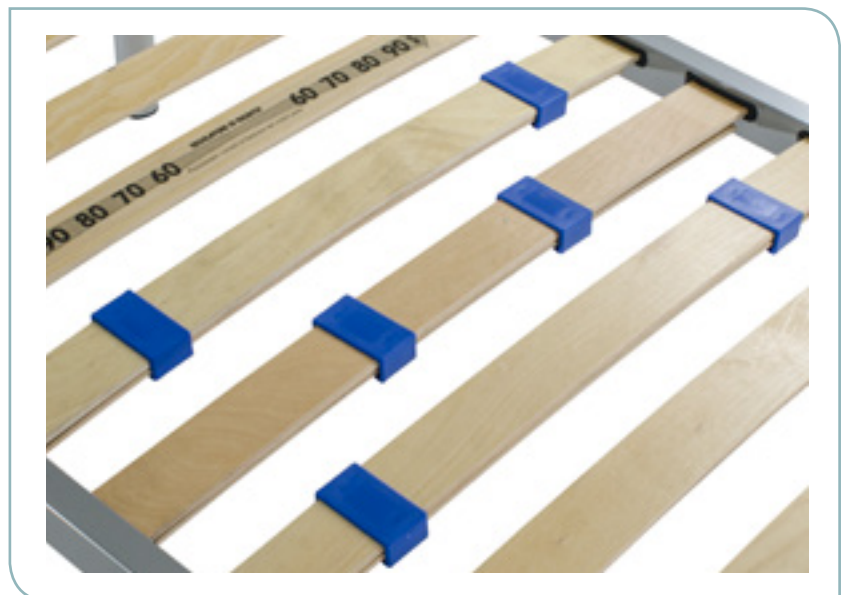

Regolatore di rigidità adattabile ad ogni peso corporeo
Firmness regulators adaptable to any body weight

A series of horizontal dashed lines for writing.

A series of 25 horizontal dashed lines spanning the width of the page, intended for writing or drawing.

Condizioni di garanzia

ALTAFLEX SRL offre su tutti i meccanismi per divani letto una garanzia di 2 anni.

La garanzia sarà valida alle seguenti condizioni:

- al meccanismo deve essere stata fatta una corretta manutenzione (vedi in seguito);
- deve essere provato che la rottura sia dovuta a difetti di produzione e non ad uso errato del meccanismo come ad esempio:
 - lasciare coperte, cuscini o altro all'interno del meccanismo chiuso in posizione divano;
 - l'uso di materassi con misure e parametri diversi da quelli indicati;
 - l'errato montaggio dei cuscini della seduta;
 - l'errato montaggio di altri particolari del divano.

Manutenzione

Tutti i meccanismi necessitano di una corretta manutenzione per garantire una buona efficienza ed efficacia nel tempo.

I punti da rispettare per una corretta manutenzione sono:

- lubrificare almeno 2 volte all'anno i leveraggi della parte meccanica di movimentazione (vedere foto e punti indicati). La mancata lubrificazione dei leveraggi può portare ad un cigolio/rumorosità del meccanismo e ad un funzionamento non buono, che può far insorgere altri problemi. Si consiglia uno spray lubrificante silconico;
- rimuovere periodicamente polvere e sporcizia dalle parti meccaniche;
- è consigliato inserire un salva materasso tra il piano letto e il materasso per evitare danneggiamenti al rivestimento del materasso, provocati dai componenti meccanici.

Tale garanzia è accordata esclusivamente ai clienti ALTAFLEX SRL che hanno acquistato i meccanismi per divano letto. Il valore compensato dalla garanzia non potrà mai superare il prezzo del meccanismo stesso.

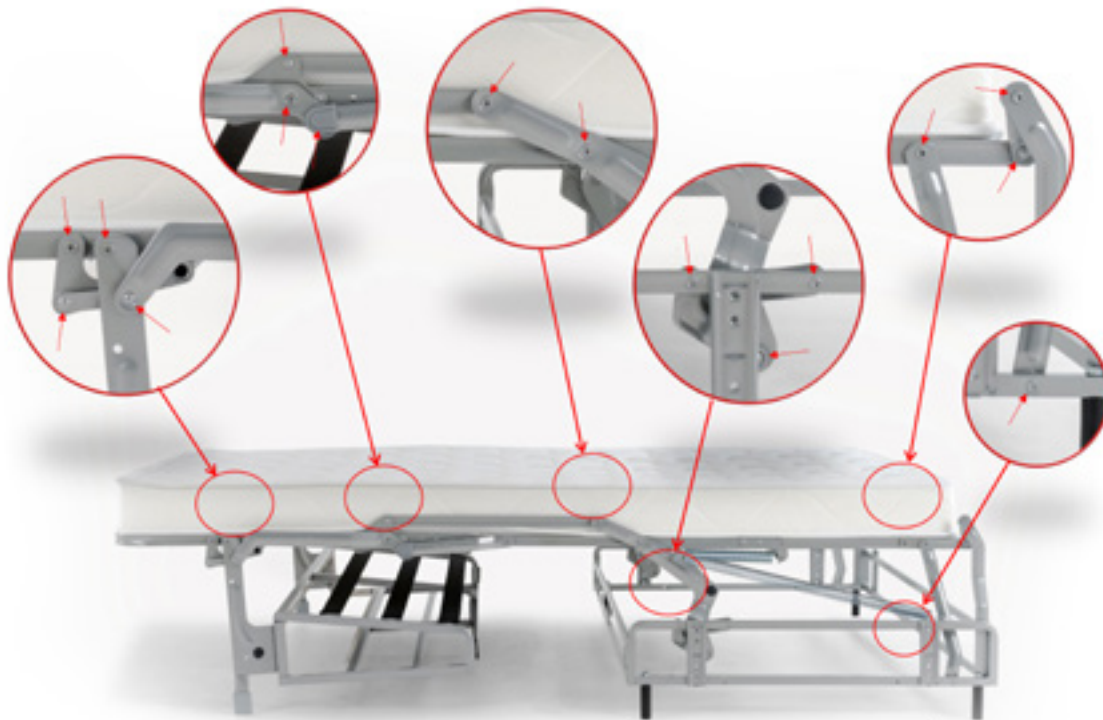

Si consiglia di lubrificare periodicamente le parti evidenziate ed, in particolare, le zone tra rivetti e leve al fine di evitare rumorosità e cigolii nell'apertura e nella chiusura del meccanismo. Si consiglia uno spray lubrificante silconico.

Attenzione

La ditta Altaflex si riserva di apportare in qualunque momento le modifiche che riterrà opportune, inoltre i colori dei prodotti sono indicativi.

Altaflex garantisce il funzionamento dei prodotti a condizione che vengano utilizzati correttamente e che si impieghino i materassi di propria produzione; pertanto eventuali danni causati dall'uso non corretto dei meccanismi e dall'impiego di altri materassi, sollevano la ditta Altaflex da qualsiasi responsabilità; è inoltre vietato chiudere all'interno della rete, coperte, lenzuola o altro, ad eccezione del solo materasso.

I materassi per divani letto in genere, in modo particolare quelli in espanso, per il loro tipo di impiego sono soggetti ad un normale restringimento rispetto alle misure iniziali.

Tutti i piedini utilizzati a supporto dei meccanismi in questo catalogo sono da considerarsi come optional.

Attention

Altaflex Company reserves the right to make any changes it deems appropriate. In addition, the colors of the products are approximate.

Altaflex guarantees the performance of the products provided that:

- The mattresses used are of its own production, to avoid so any damage caused by incorrect use of the mechanisms and other types of mattresses.
- It is forbidden to close in the bed frame, blankets, sheets or anything except for the mattress only.
- The mattresses for sofa beds, particularly those in foam, for their type of employment shall be subject to normal shrinkage compared to the initial measures.
- All feet used to support mechanisms in this catalog are to be considered as optional.



WWW.ALTALEX.IT



altaflex[®]
sofa bed mechanisms